

Mon joli dressing

Célia Moreau
@little_c_celia

Patron à reconstituer

Nos patrons sont à imprimer sur du papier format A4.
Les pages sont numérotées. Les assembler bord à bord
avec du ruban adhésif. Il y a lieu de prolonger les lignes
d'une page sur l'autre avant de couper les patrons.



Schéma de montage

1	2	3
4	5	6

Droit-fil

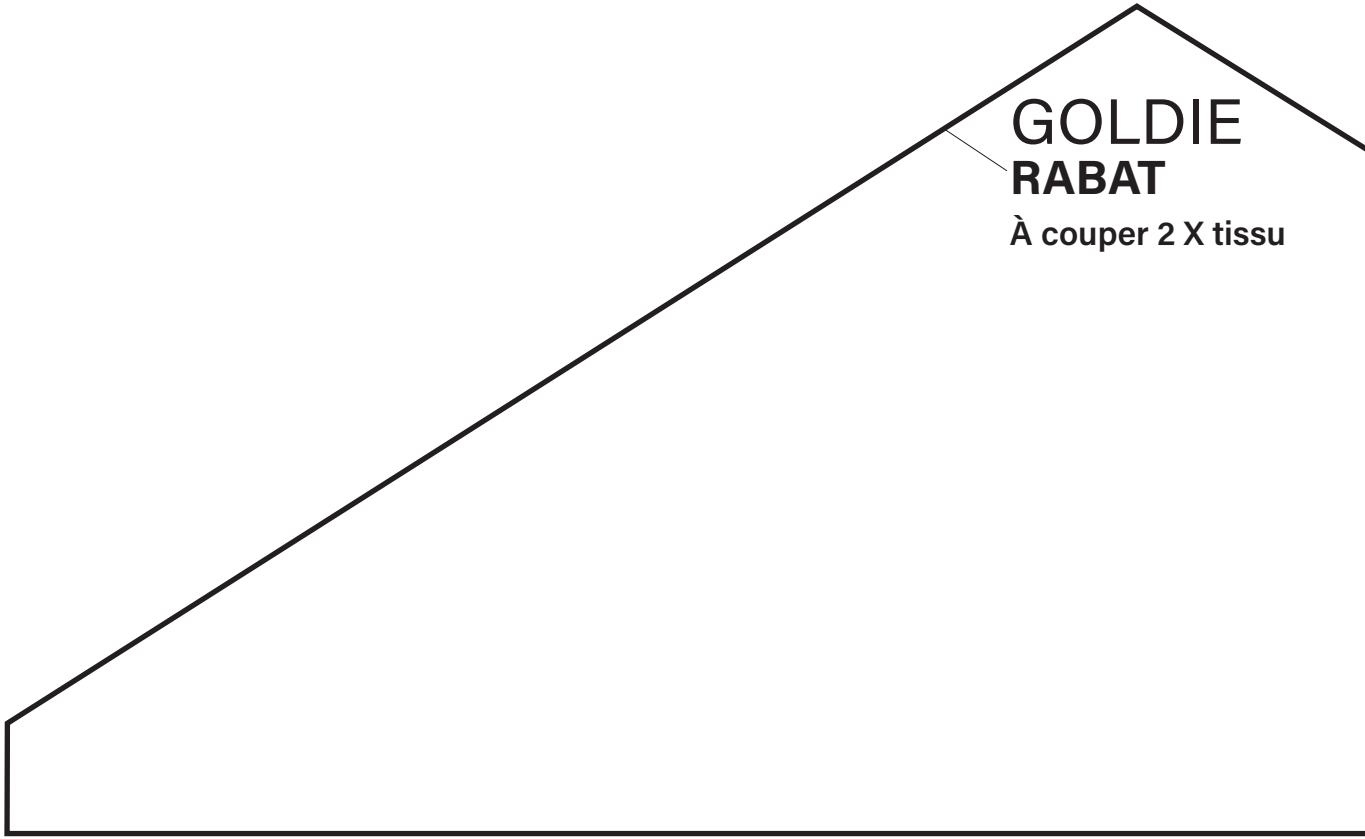

**GOLDIE
RABAT**

À couper 2 X tissu



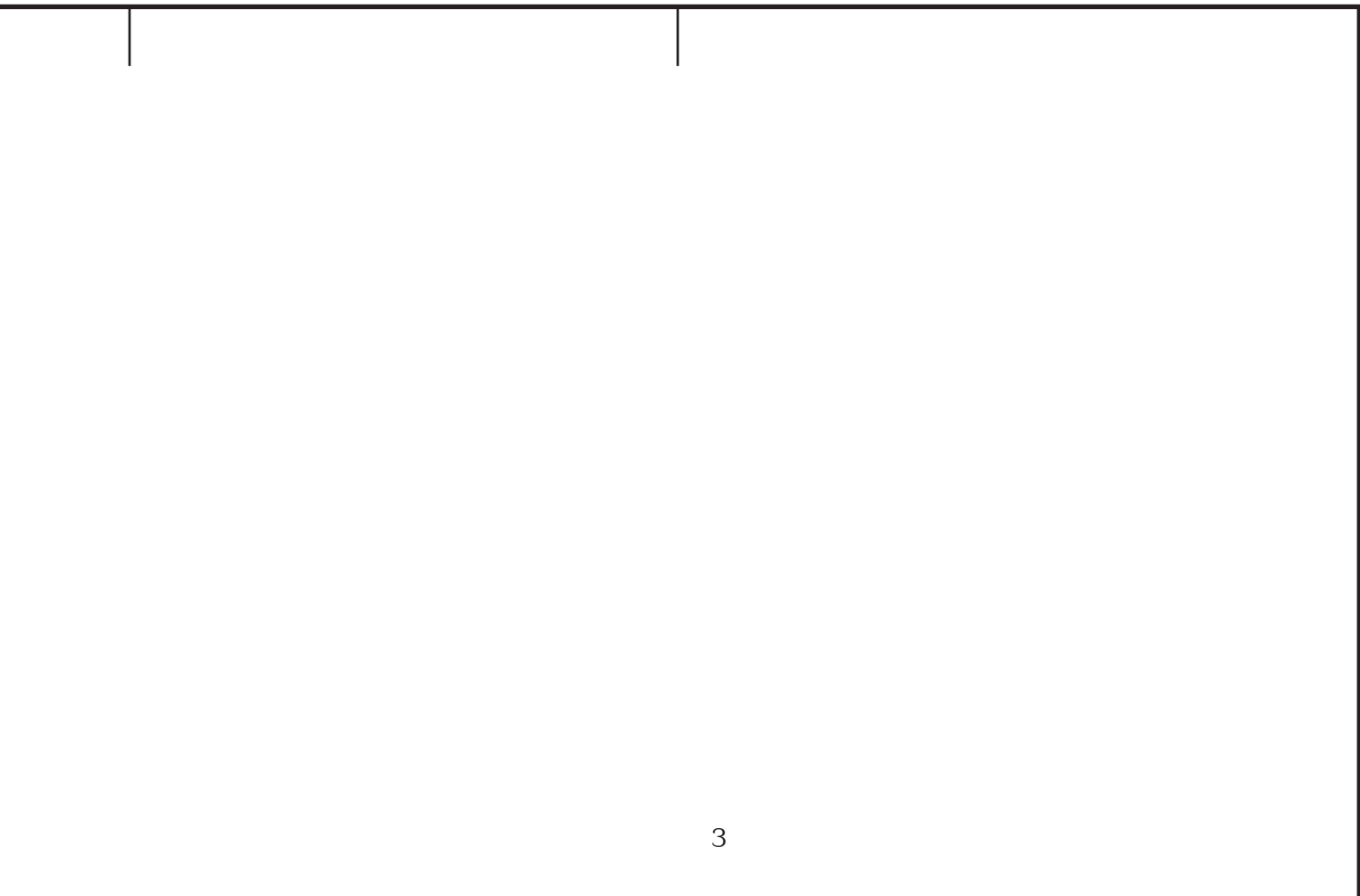
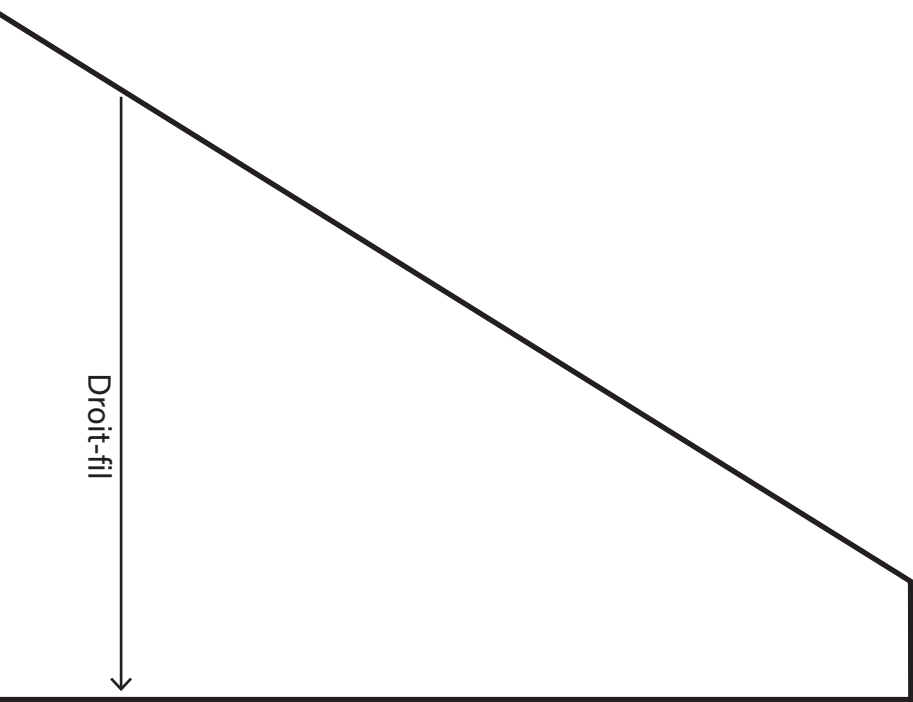

**GOLDIE
VOLANT**

À couper 1 X tissu

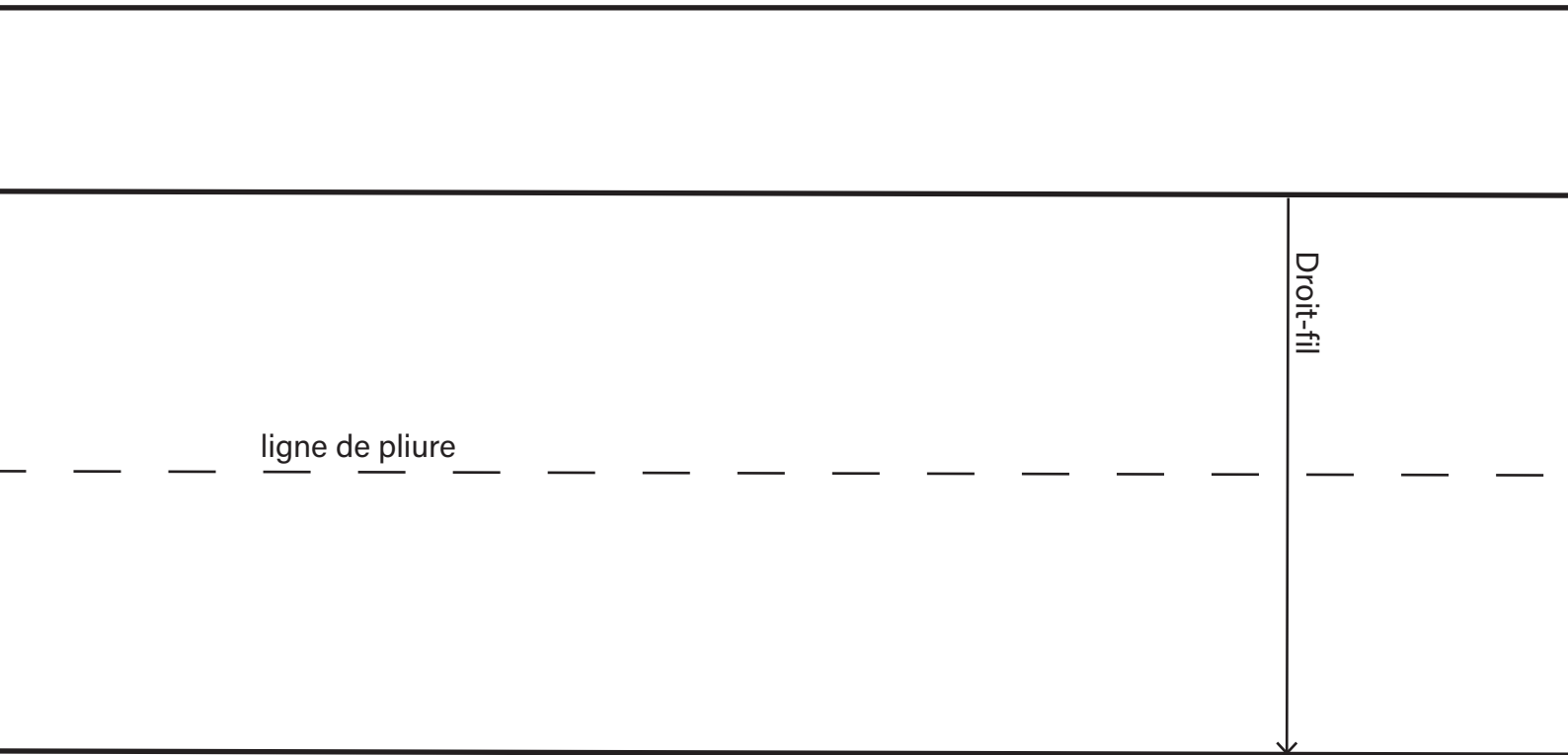

ligne de pliure

Droit-fil

**GOLDIE
CORPS**

À couper 2 X tissu

Mon joli dressing

Célia Moreau
@little_c_celia

Patron à reconstituer

Nos patrons sont à imprimer sur du papier format A4.
Les pages sont numérotées. Les assembler bord à bord
avec du ruban adhésif. Il y a lieu de prolonger les lignes
d'une page sur l'autre avant de couper les patrons.



Schéma de montage

1	2	3	4
5	6	7	8
9	10	11	12

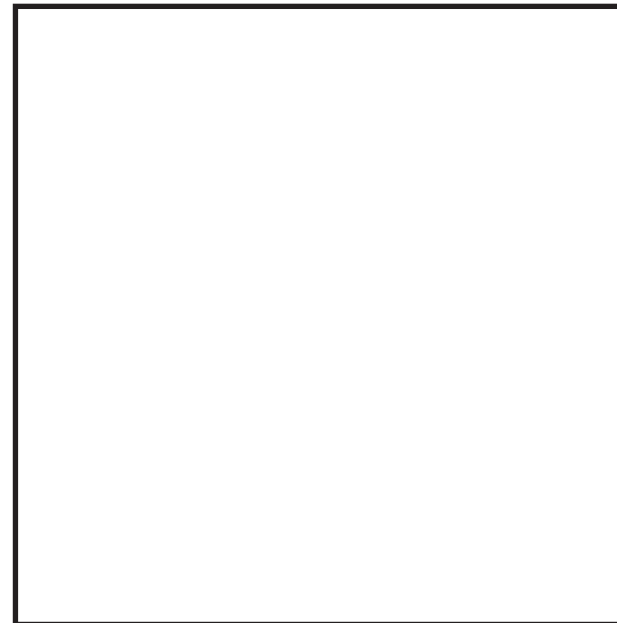



Droit-fil

HAPPY PAREMENTURE

À couper 2 X tissu

HAPPY CORPS

À couper 2 X tissu
2 X doublure
2 X ouatine

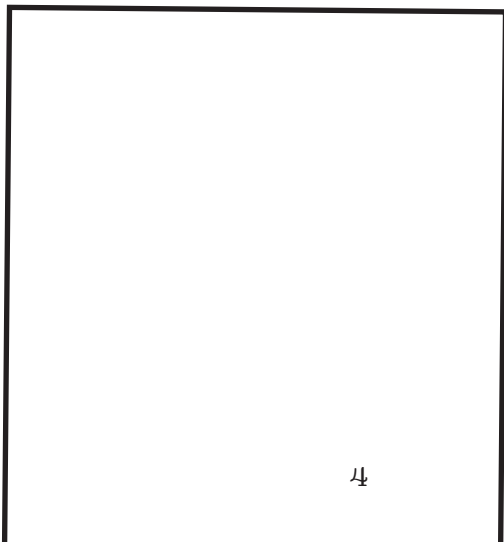
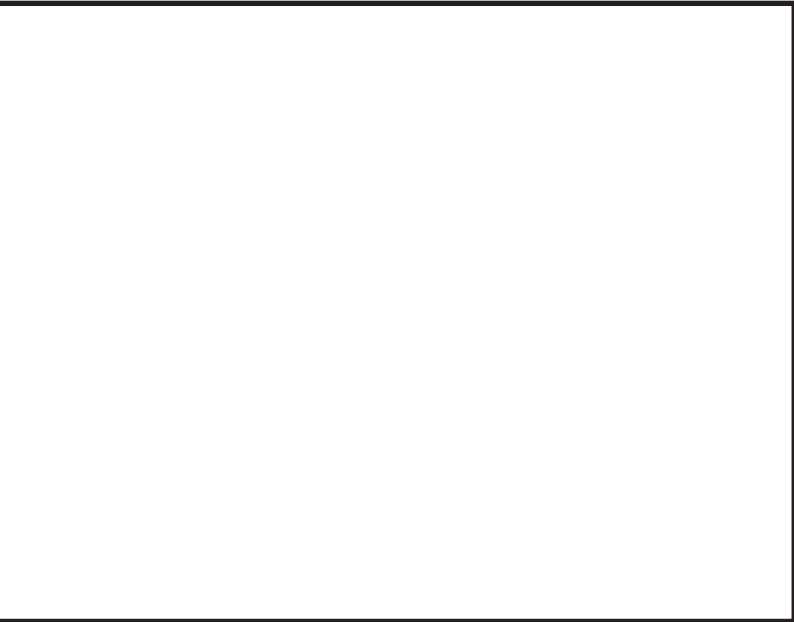

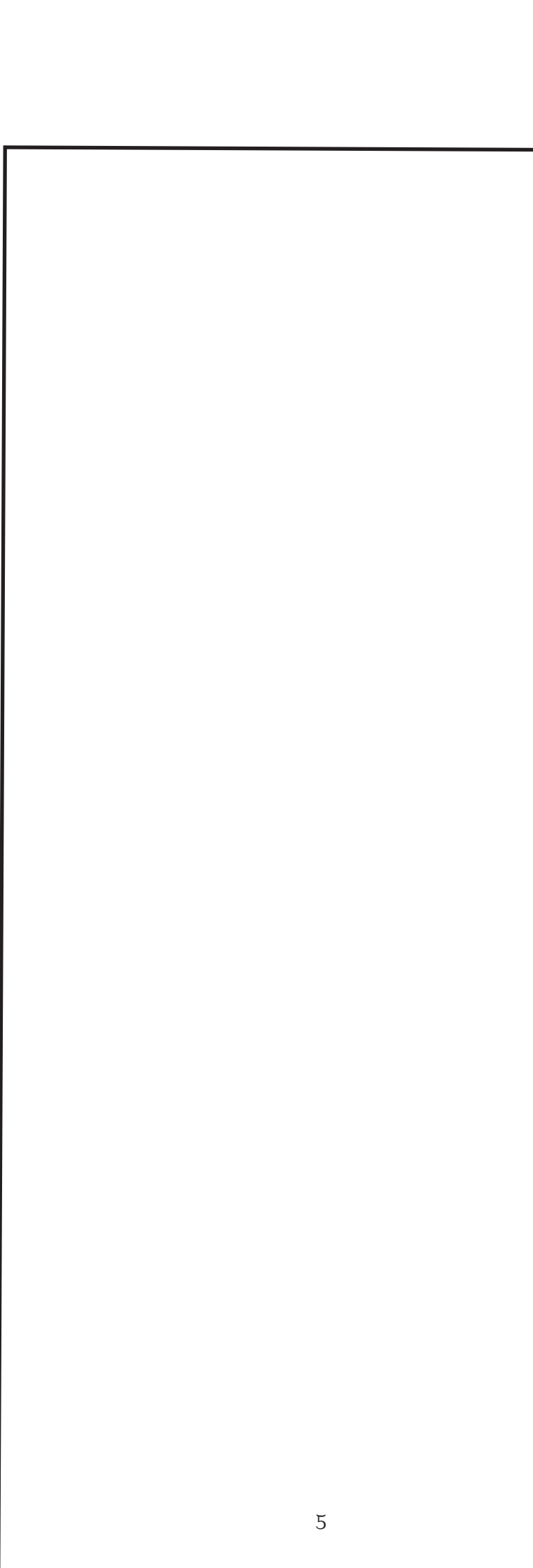

Droit-fil

repères
des anses

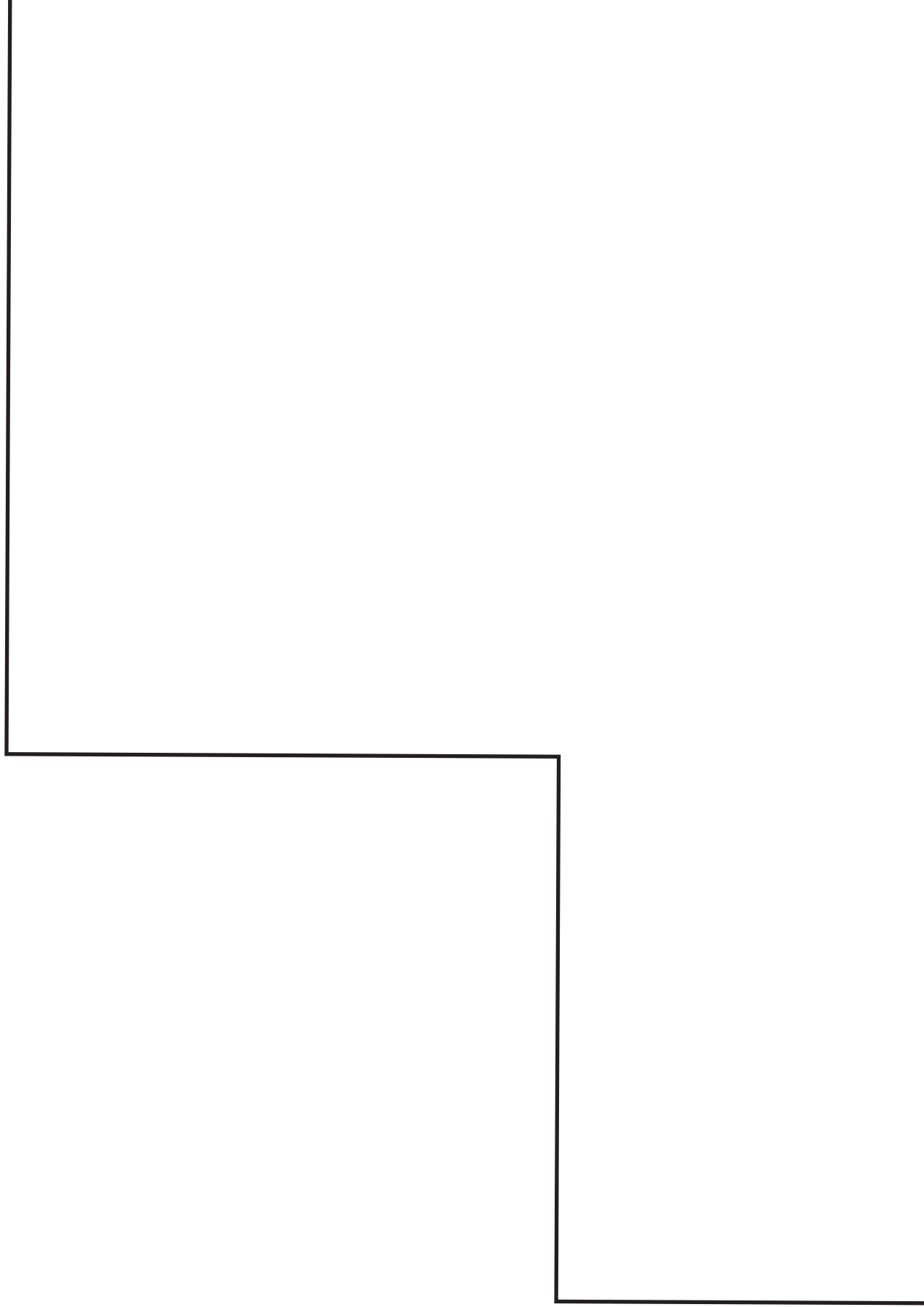



repères
des anses

**HAPPY
ANSES**

À couper 4 X tissu
et 2 X ouatine

Droit-fil



Mon joli dressing

Célia Moreau
@little_c_celia

Patron à reconstituer

Nos patrons sont à imprimer sur du papier format A4.
Les pages sont numérotées. Les assembler bord à bord
avec du ruban adhésif. Il y a lieu de prolonger les lignes
d'une page sur l'autre avant de couper les patrons.



Schéma de montage

1	2	3	4
5	6	7	8
9	10	11	12

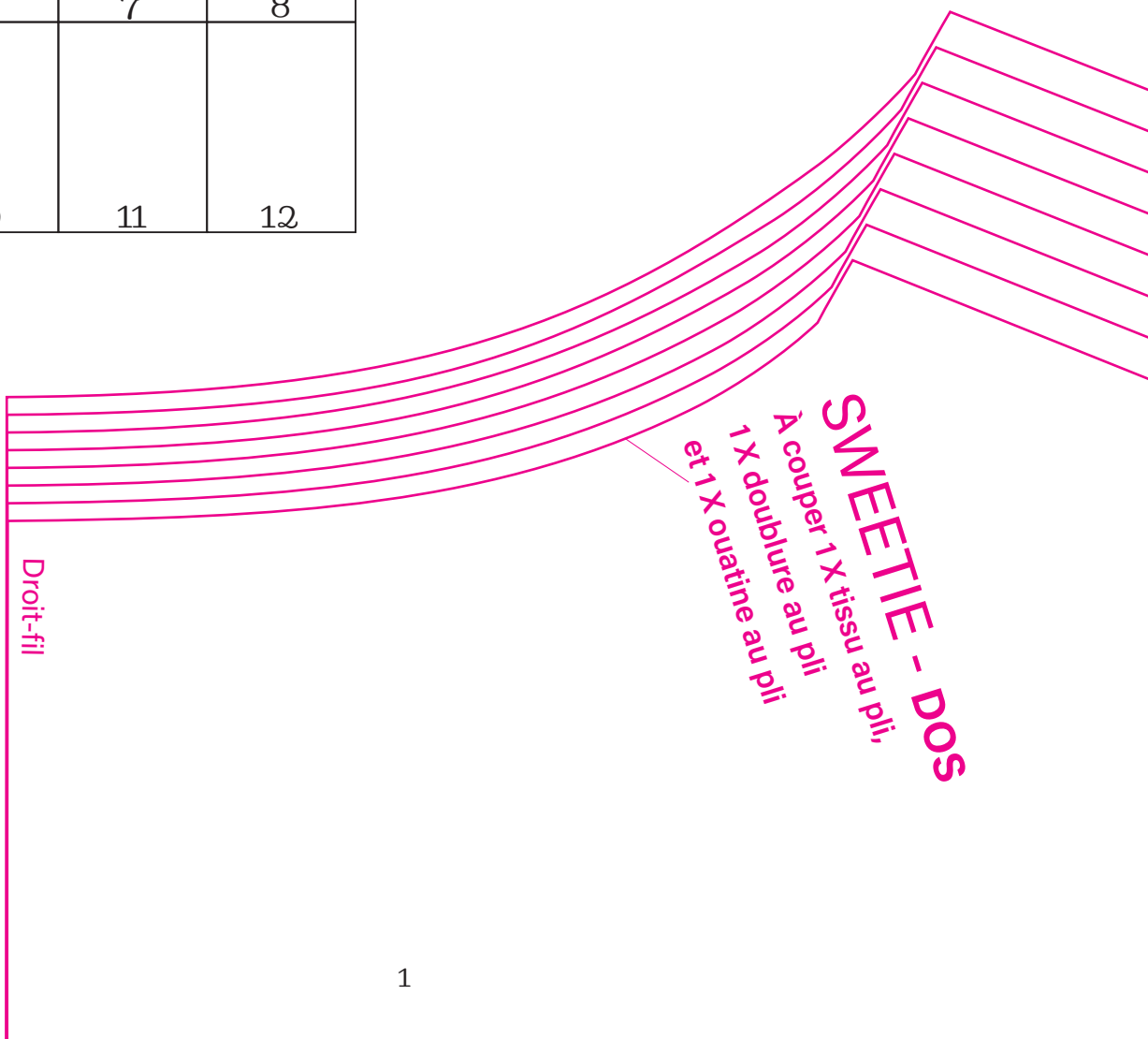

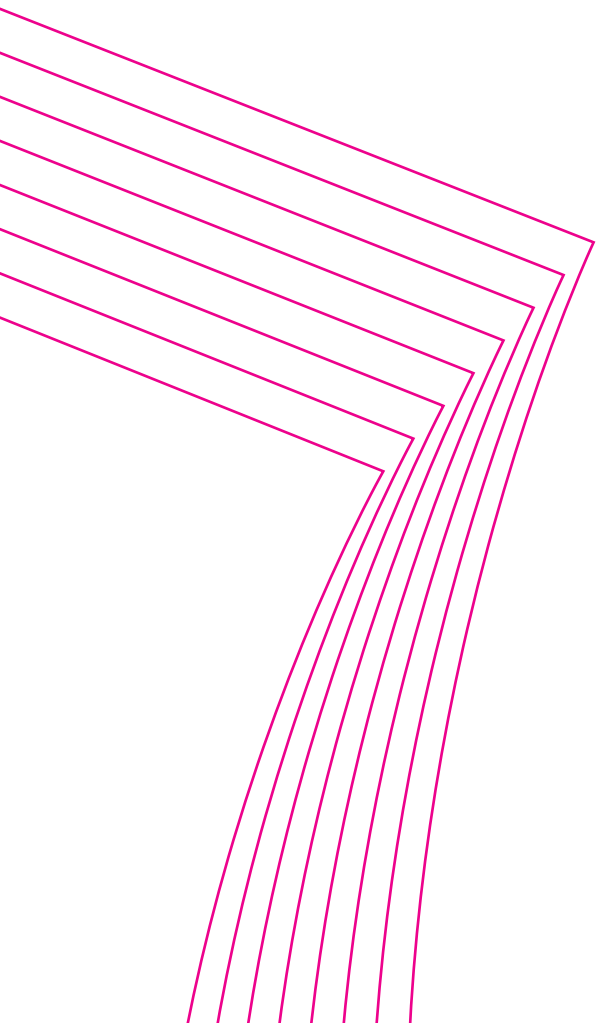

SWEETIE
DEVANT
À couper 2 X tissu,
2 X doublure
et 2 X ouatine

repère
fin du
volant

Droit-fil

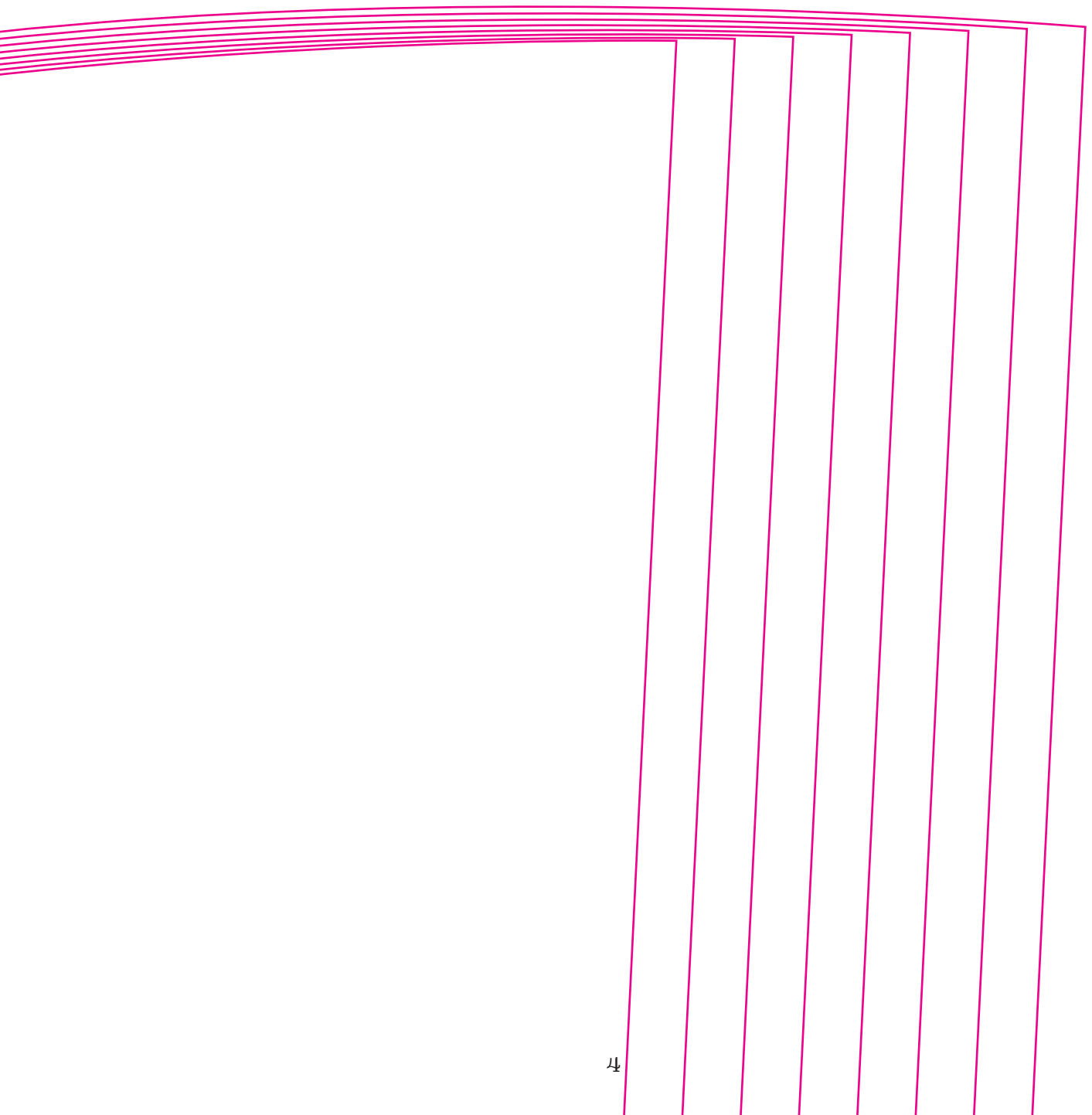

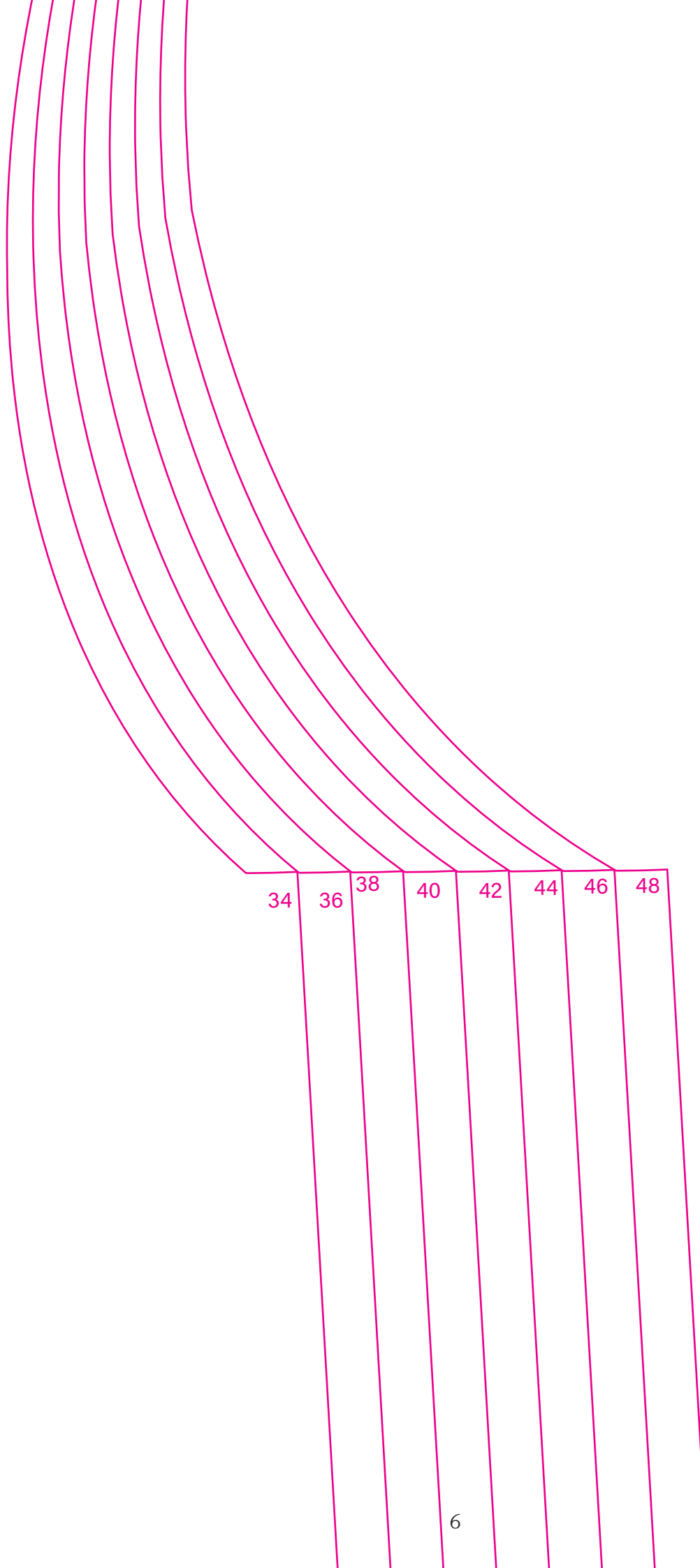

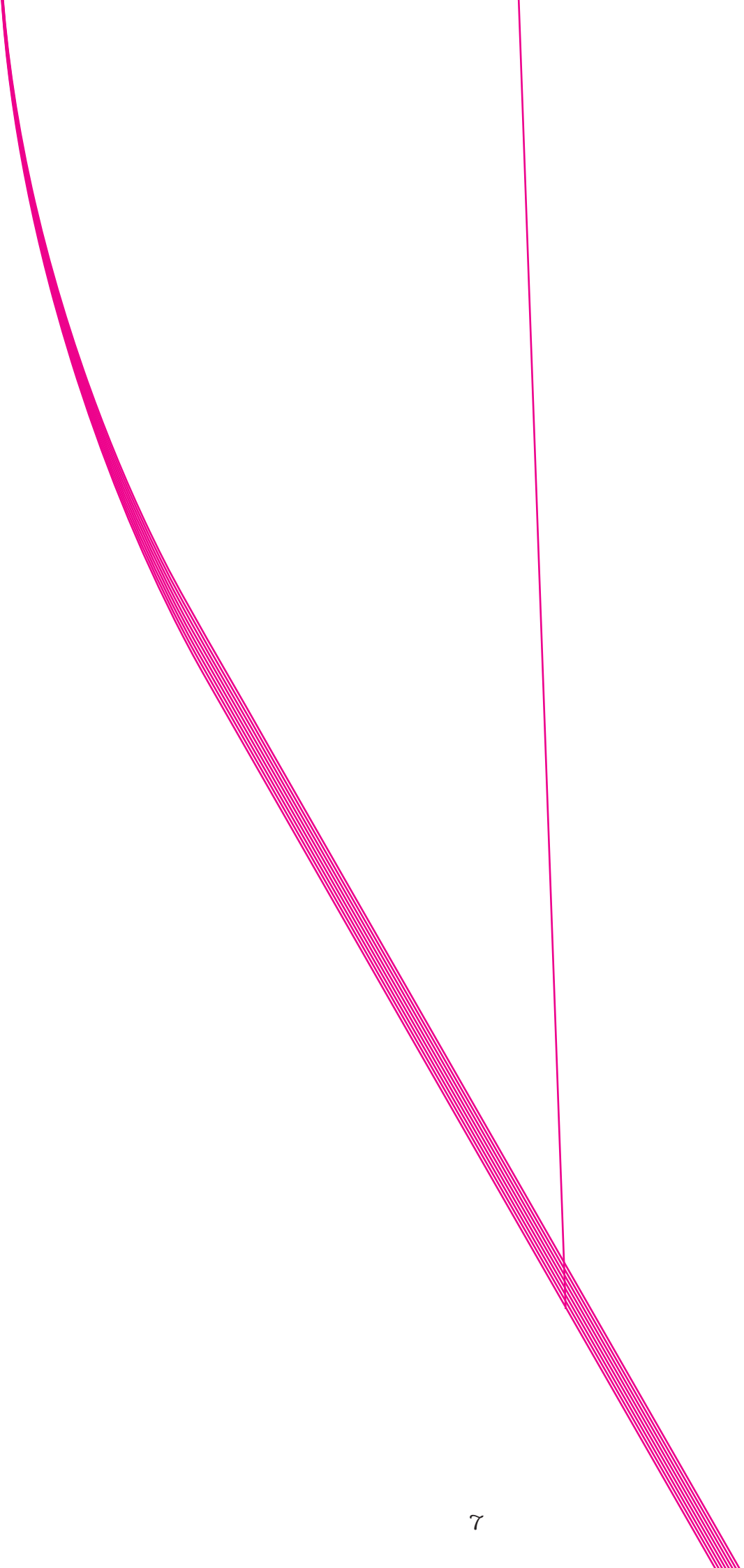

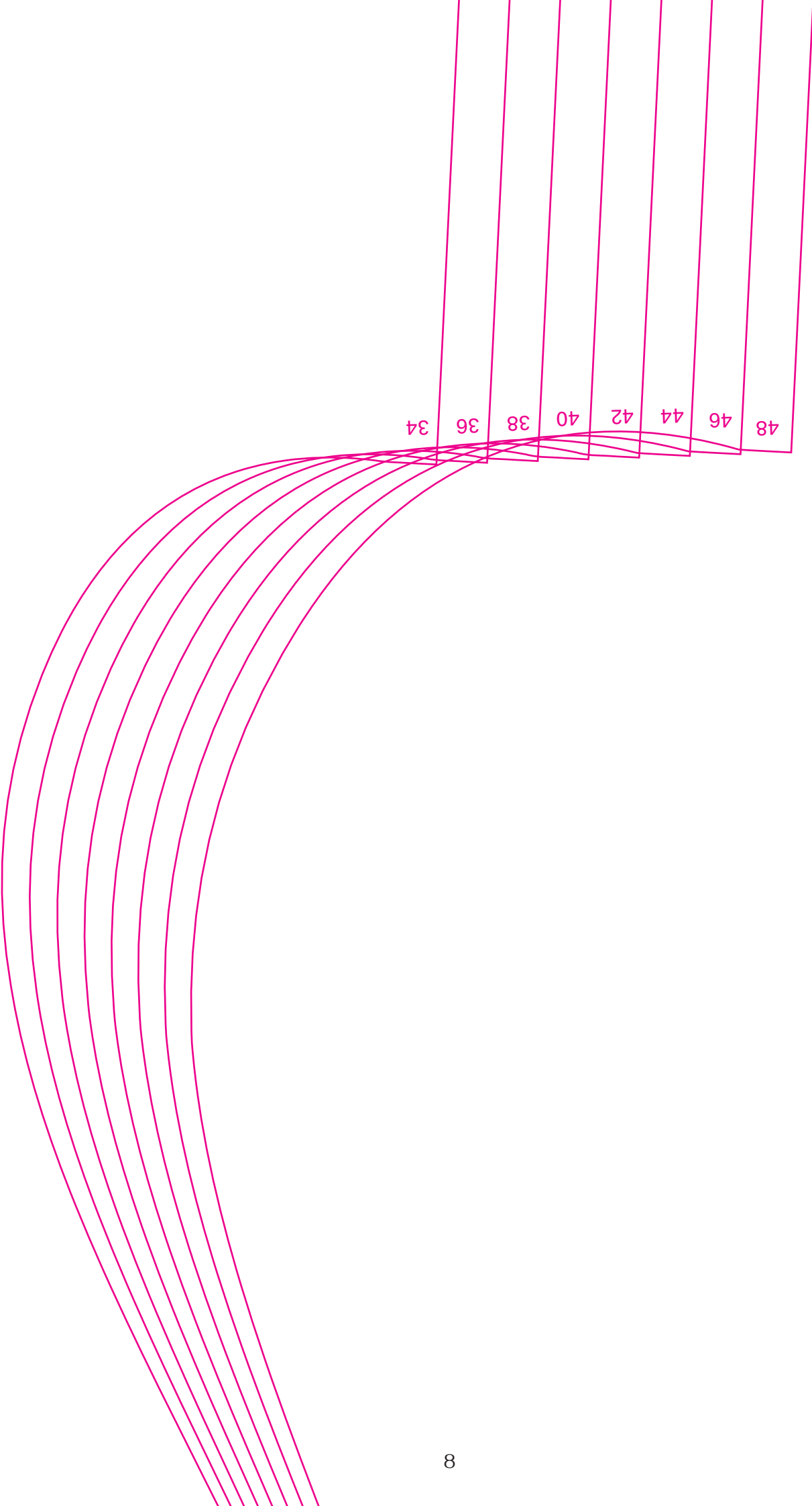

id ne

48
46
44
42
40
38
36
34



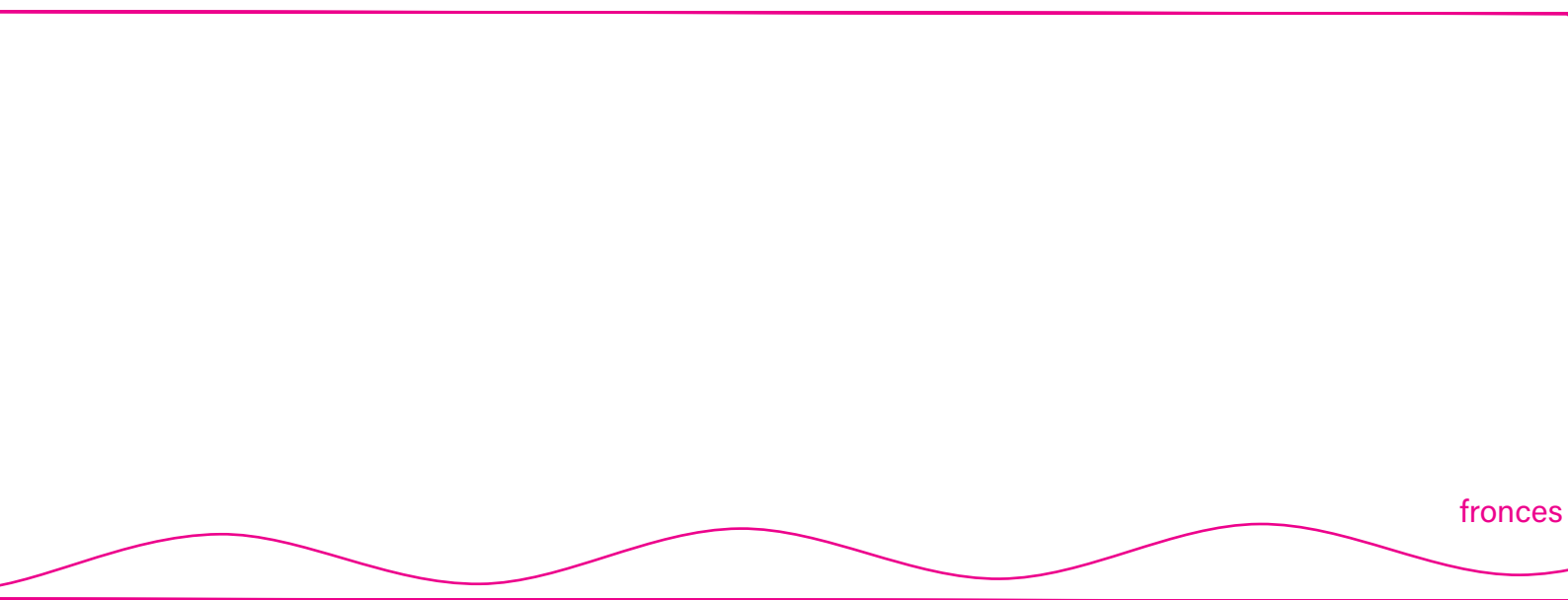
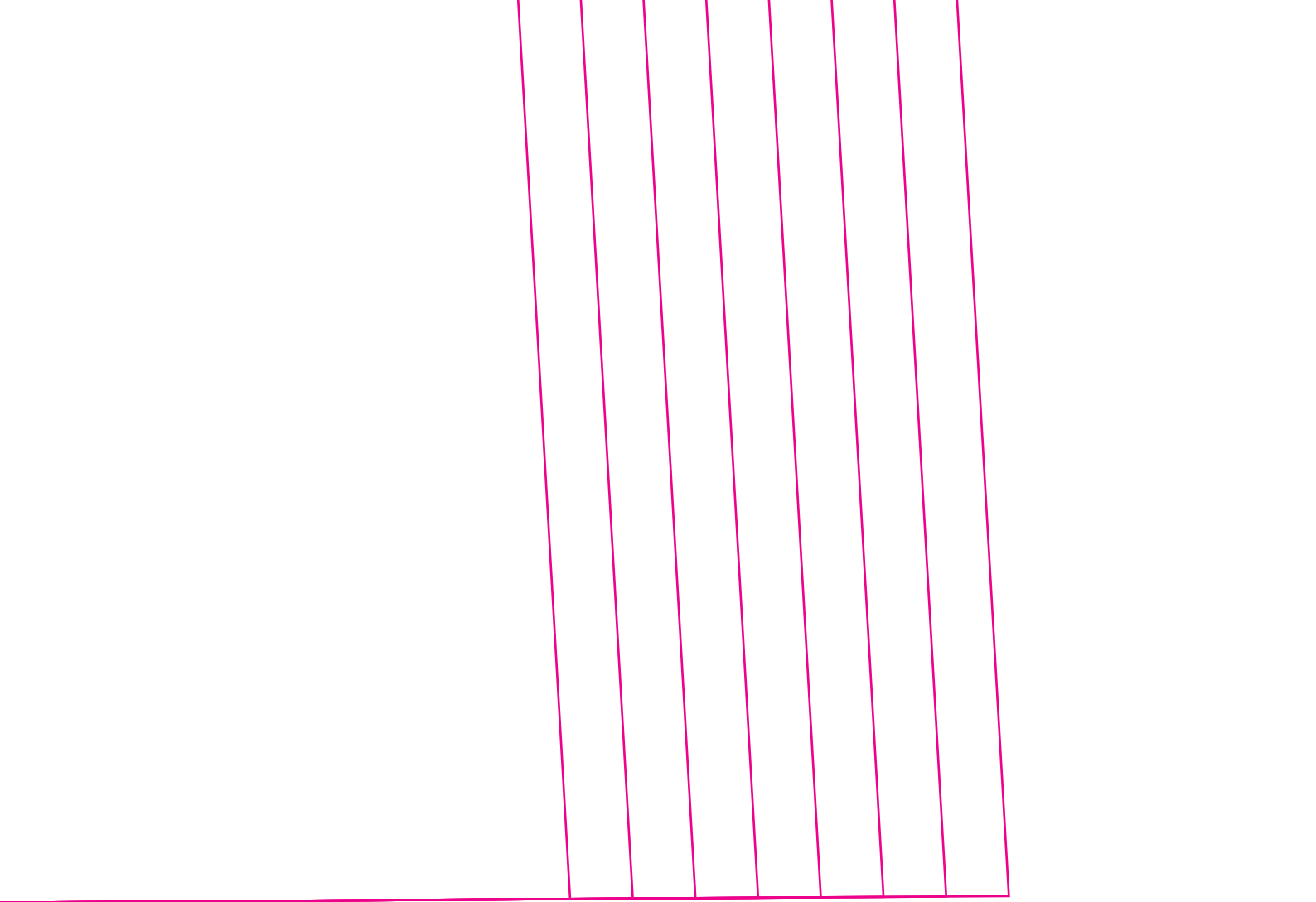

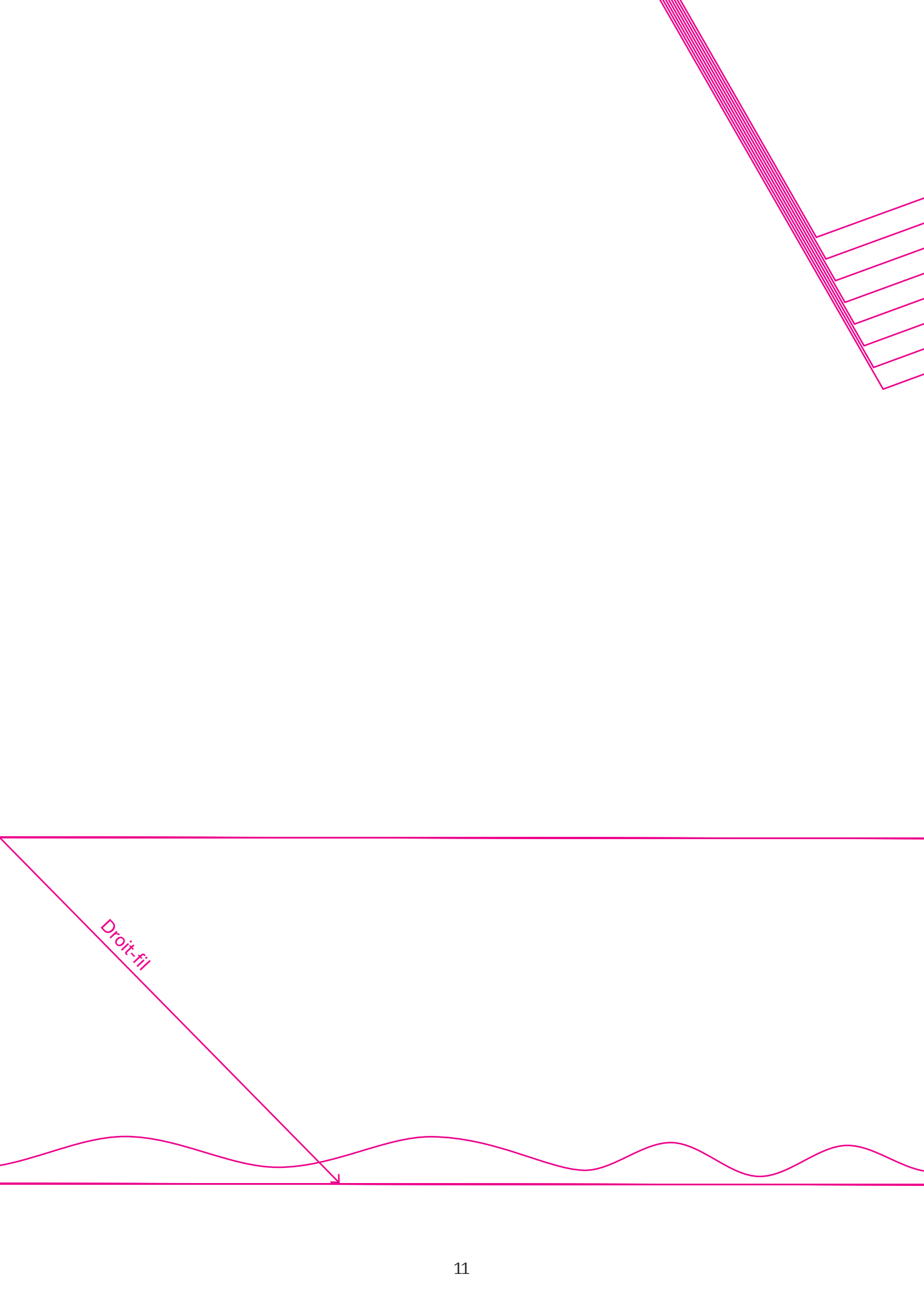

Droit-fil

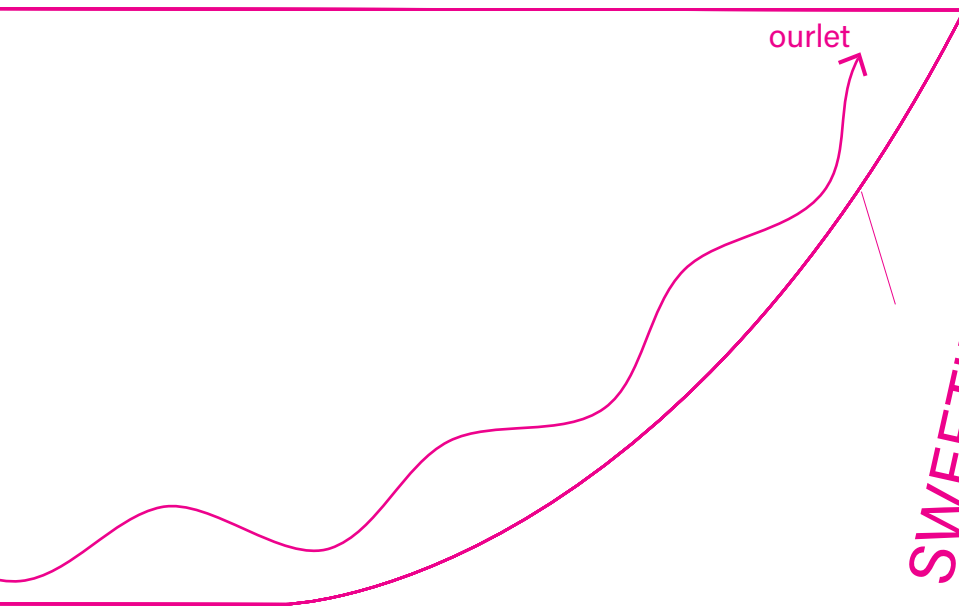
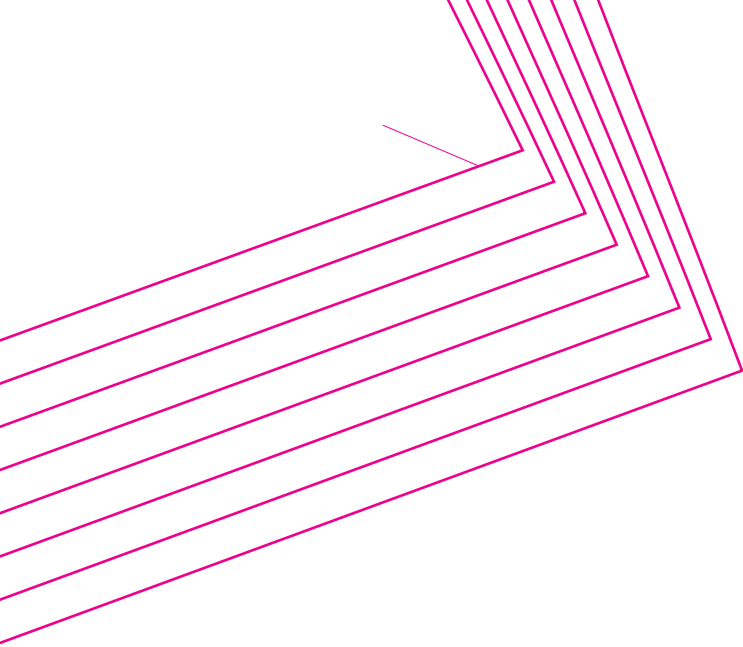

SWEETIE - VOLANT
À couper 2 X tissu

Mon joli dressing

Célia Moreau
@little_c_celia

Carré d'essai
5 x 5 cm

Patron à reconstituer

Nos patrons sont à imprimer sur du papier format A4.
Les pages sont numérotées. Les assembler bord à bord
avec du ruban adhésif. Il y a lieu de prolonger les lignes
d'une page sur l'autre avant de couper les patrons.

Schéma de montage

1	2	3	4	5	6	7	8
9	10	11	12	13	14	15	16
17	18	19	20	21	22		
23	24	25	26	27	28		

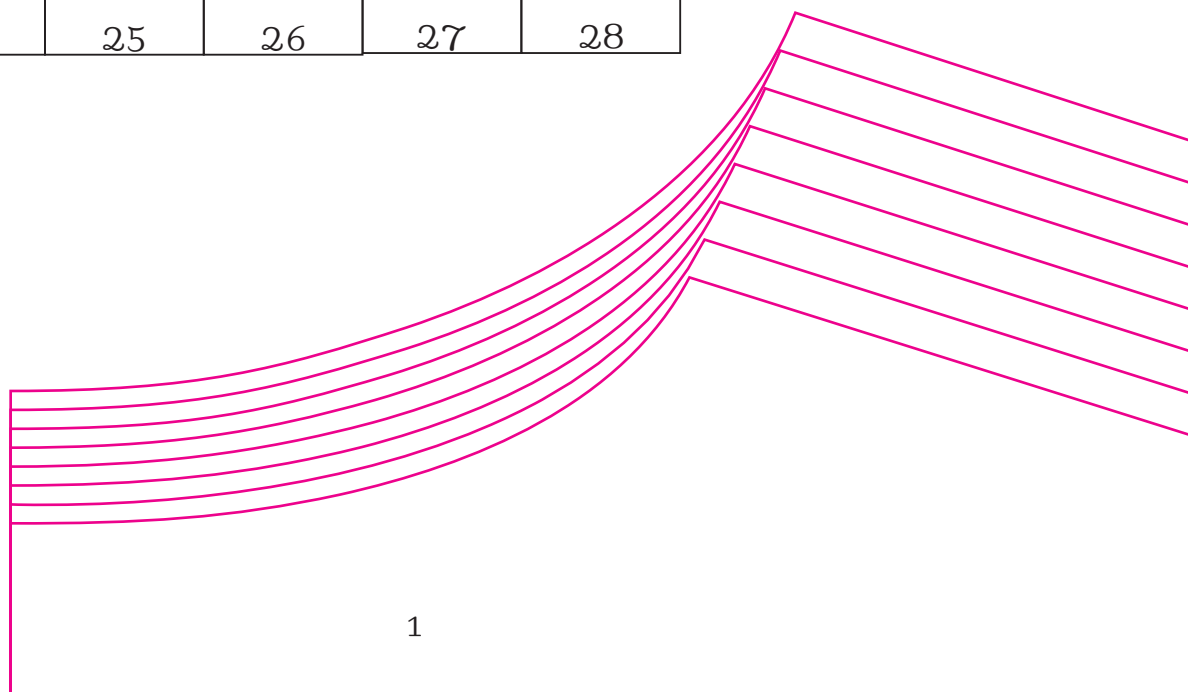

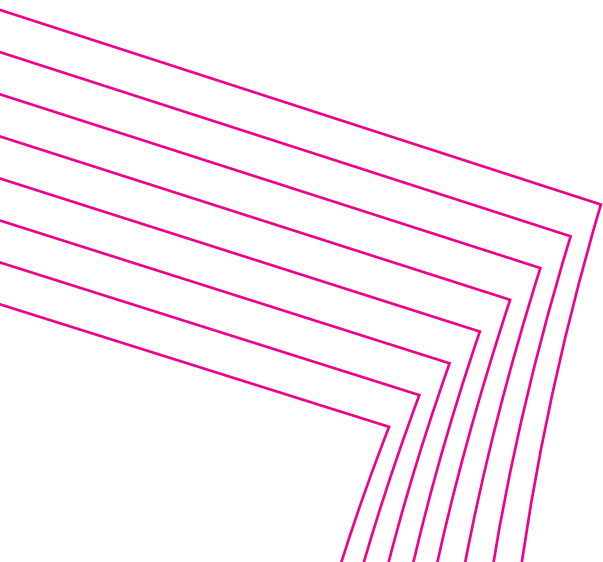

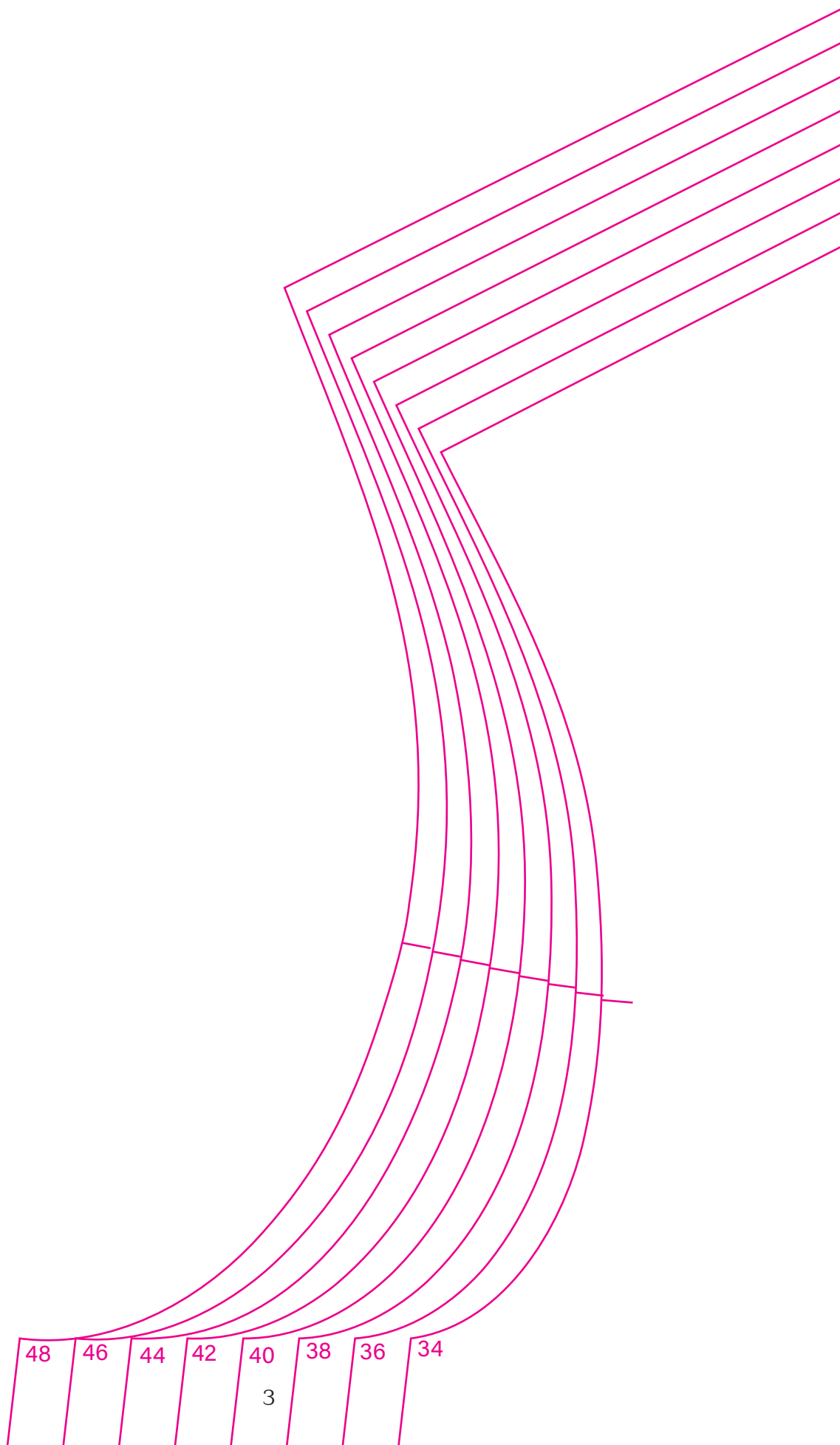

SEVENTIE - DEVANT

À couper 2 X tissu

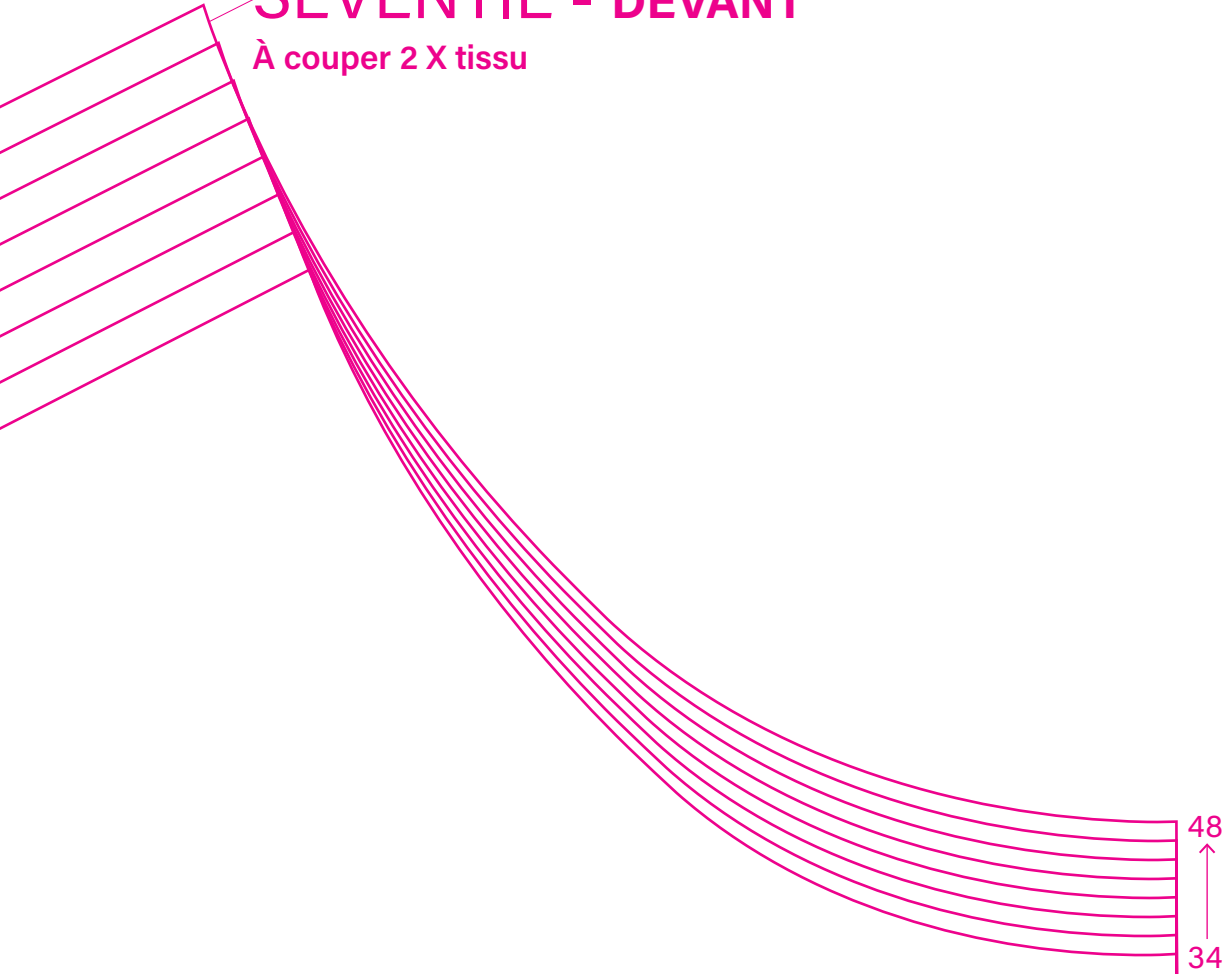

Droit-fil

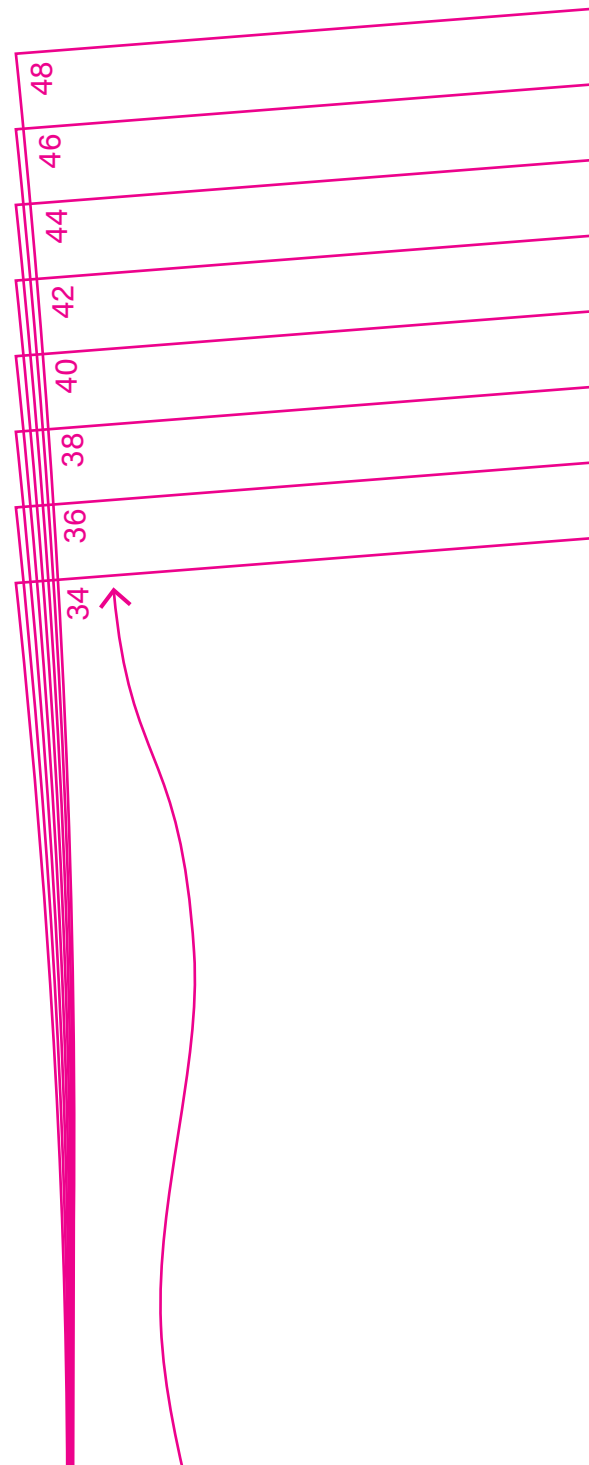
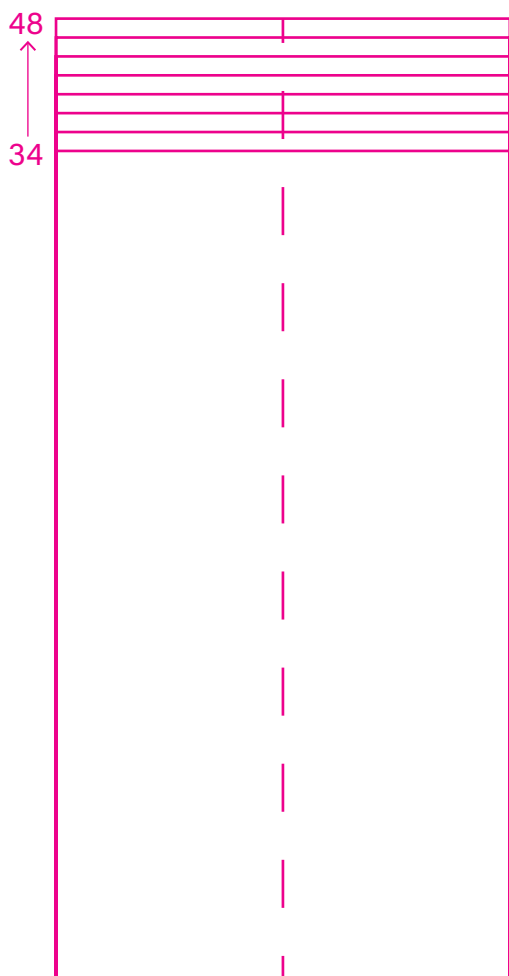

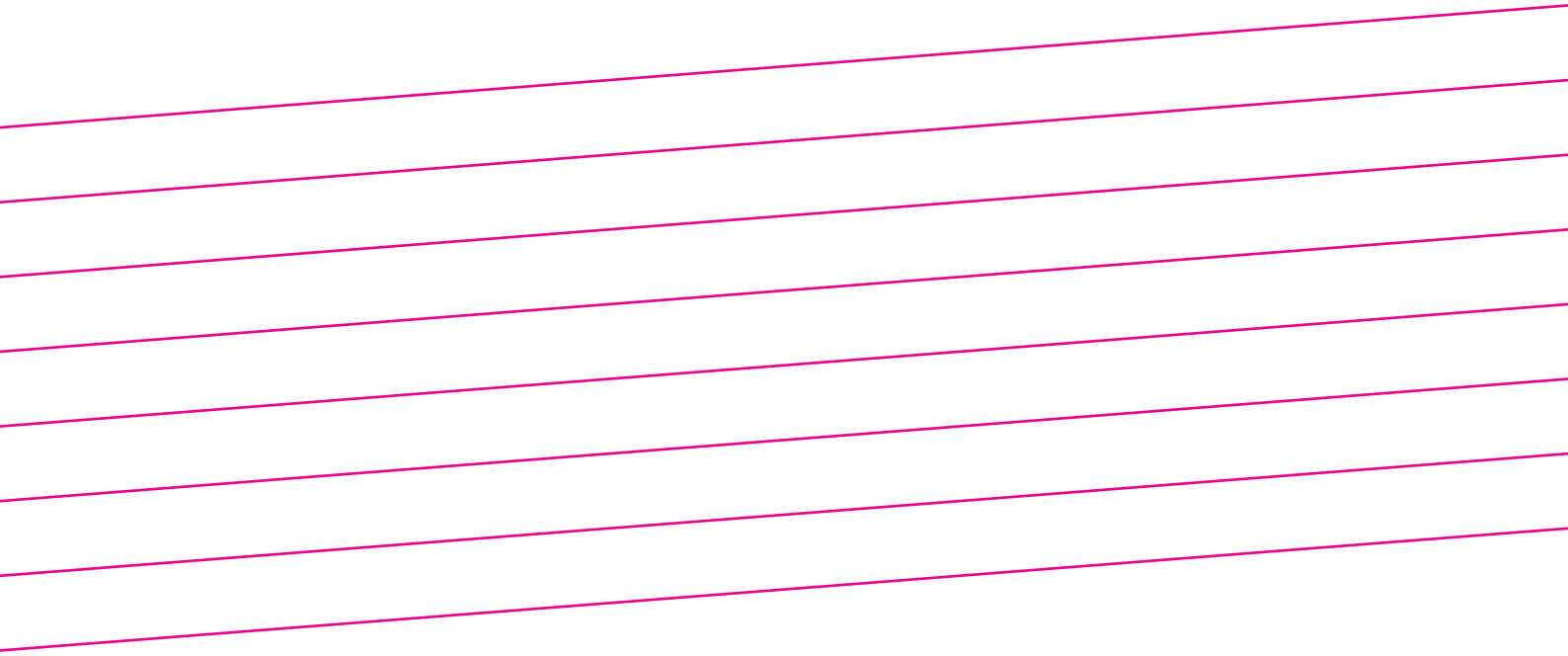

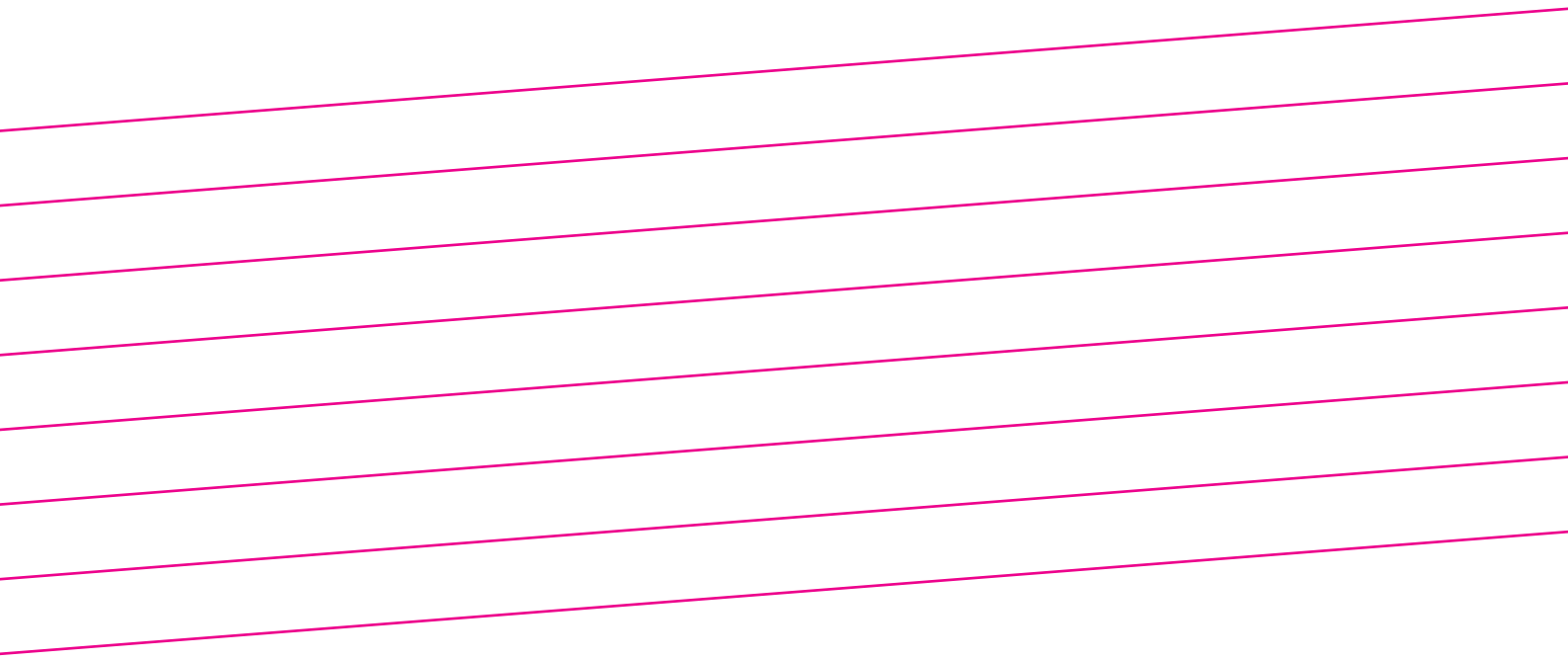

**SEVENTIE
JUPE DEVANT**

À couper 2 X tissu

JUPE DOS

À couper 1 X tissu au pli



milieu dos / Droit-fil

SEVENTIE - DOS

À couper 1 X tissu au pli



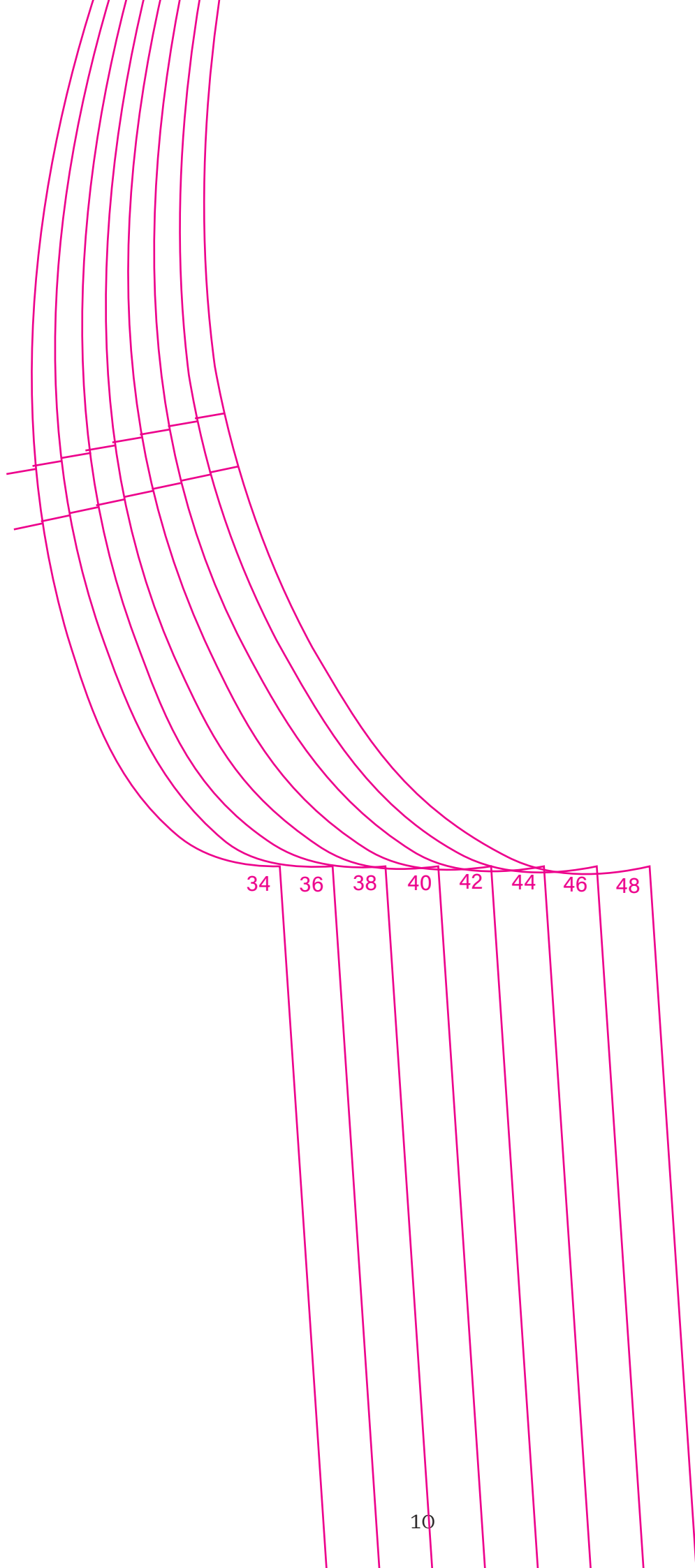

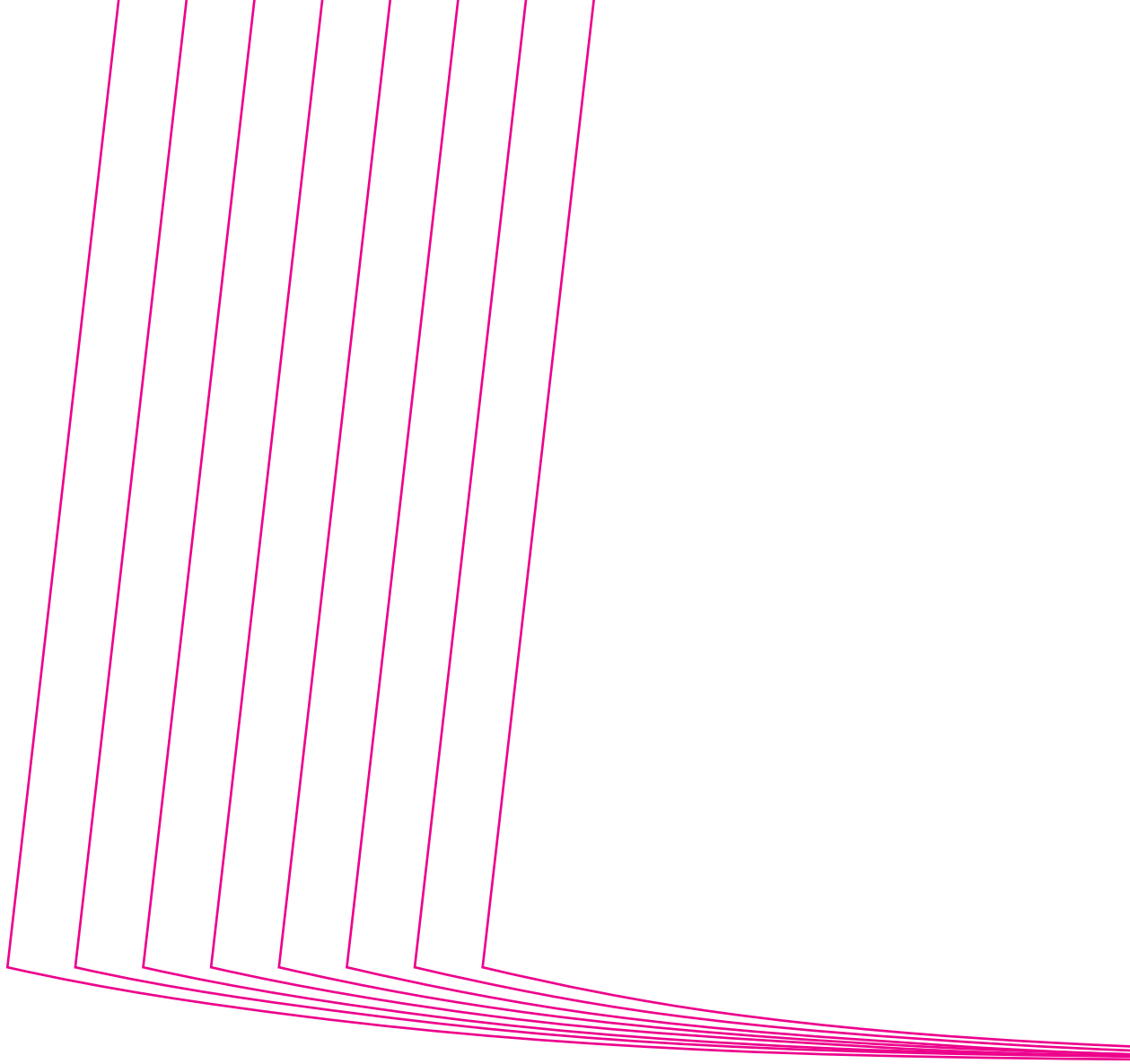

-fil

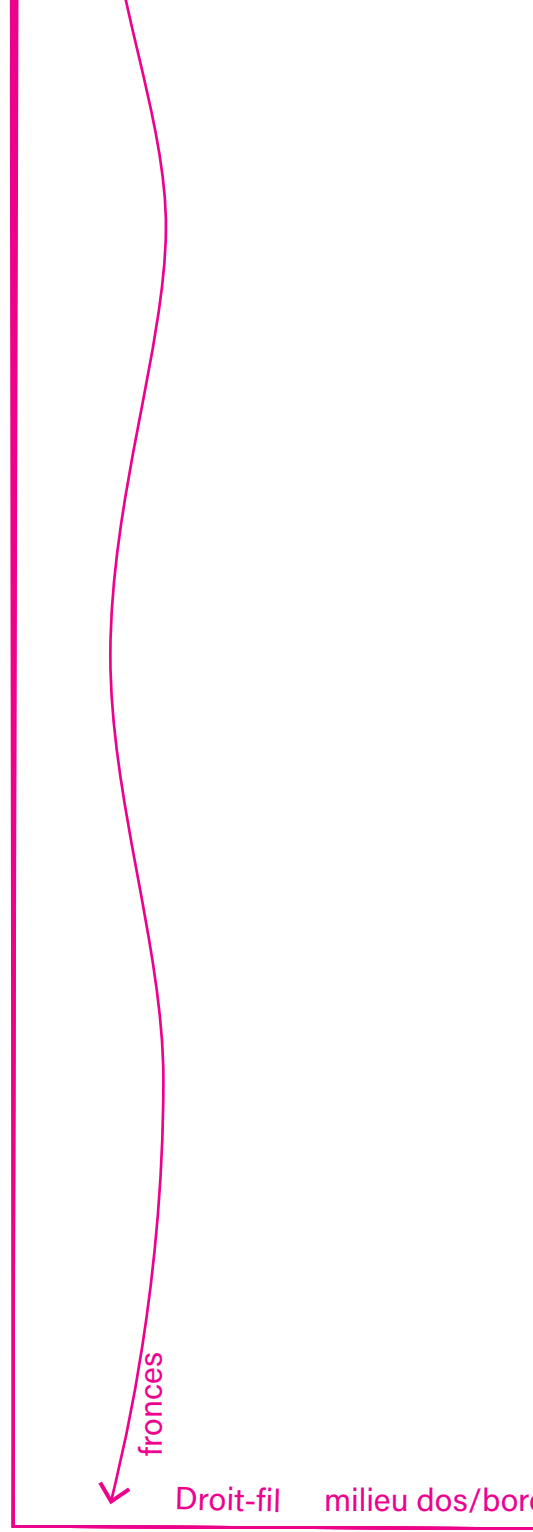

d devant

au pli (dos)



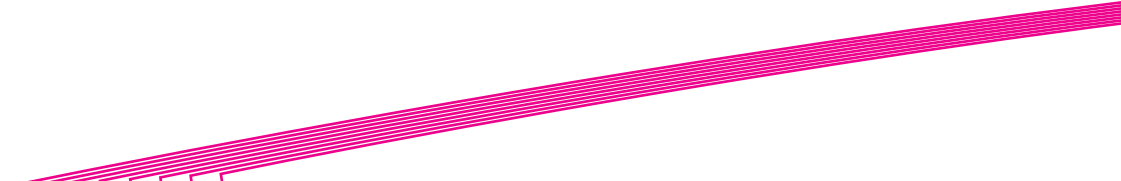

34 36 38 40 42 44 46 48

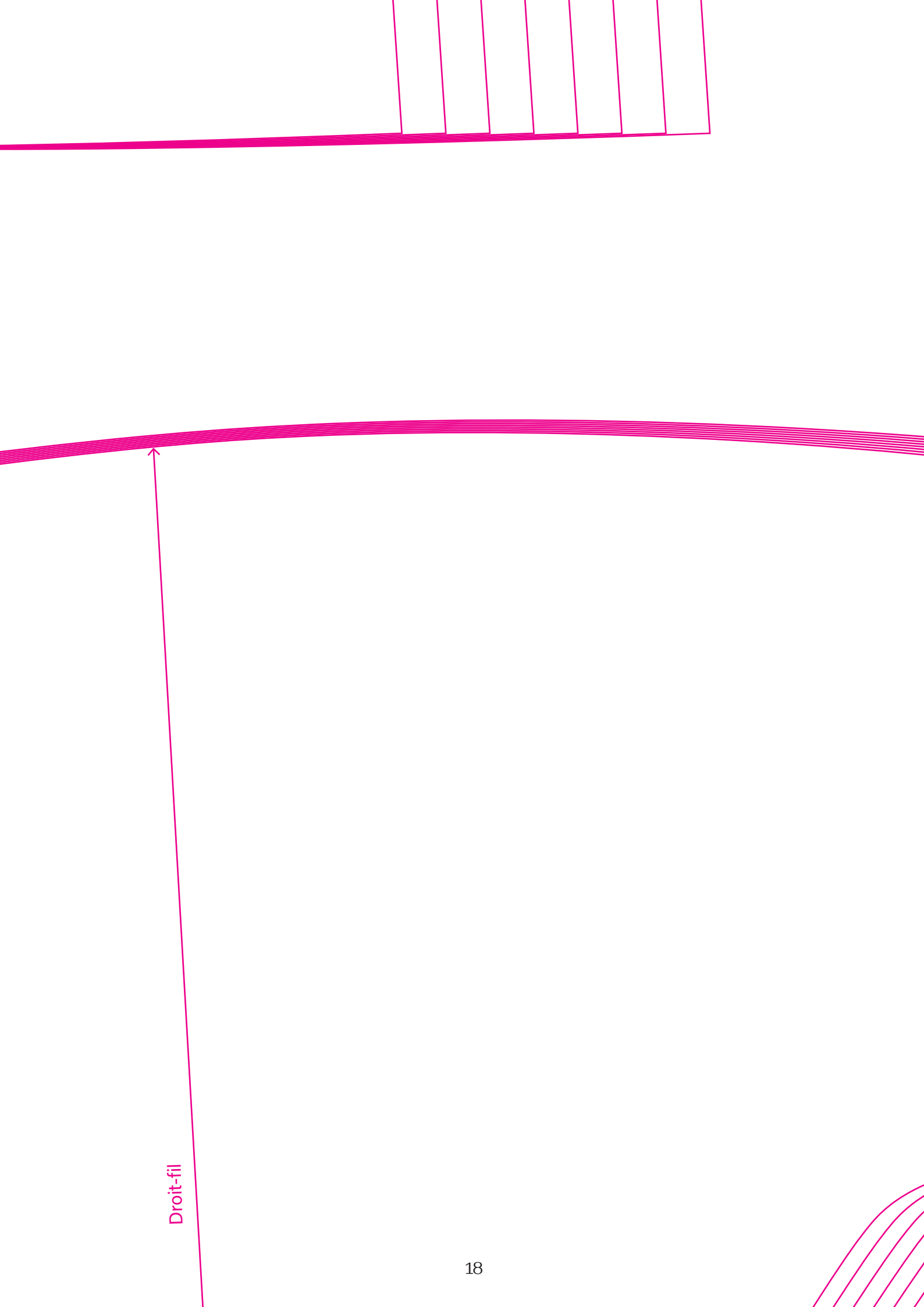

Droit-fil

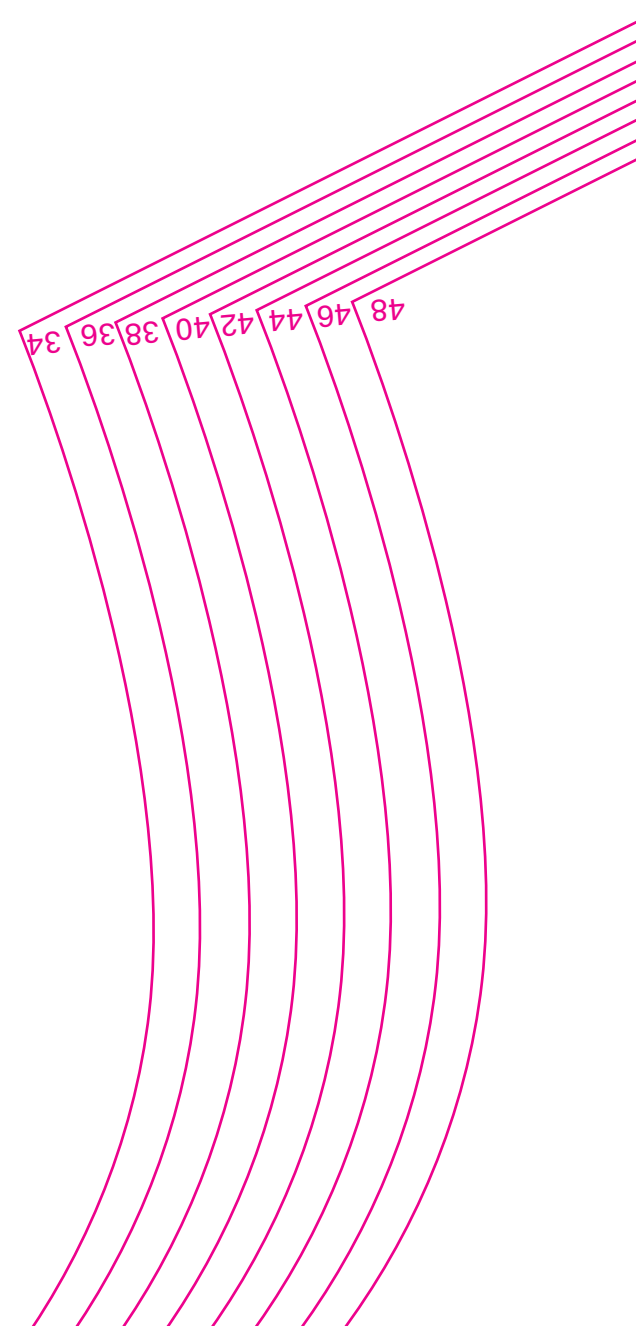
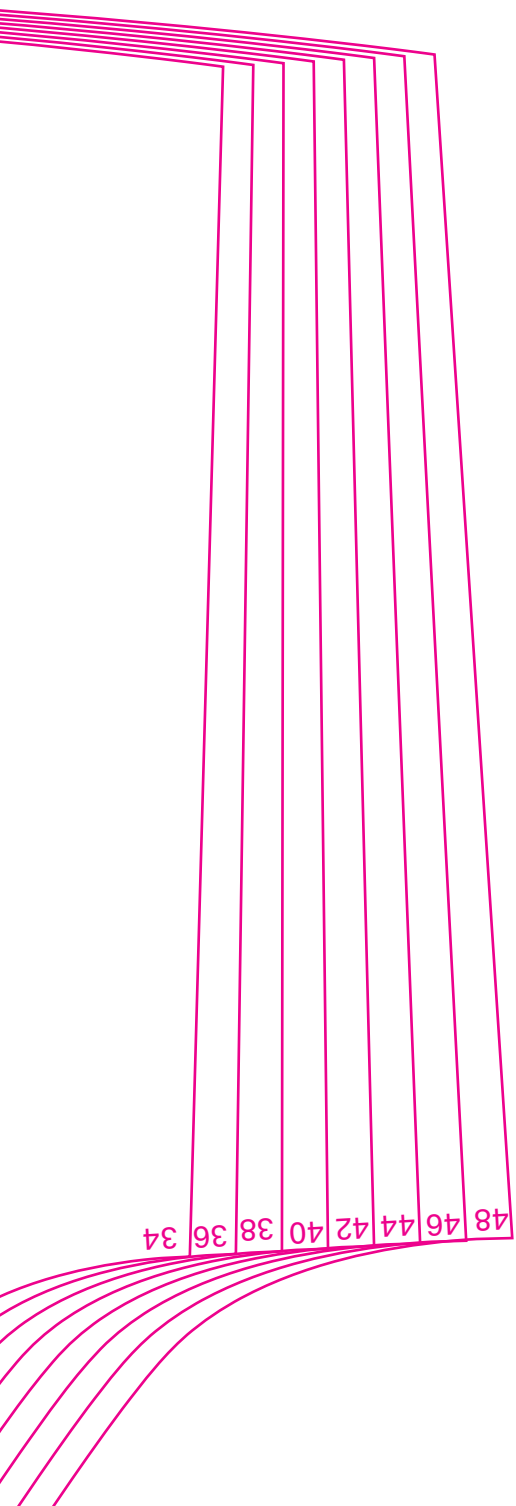



ligne de pliure

Droit

SEVENTIE BAS DE MANCHE

À couper 2 X tissu au pli

milieu de manche

Droit-fil

fronces



and

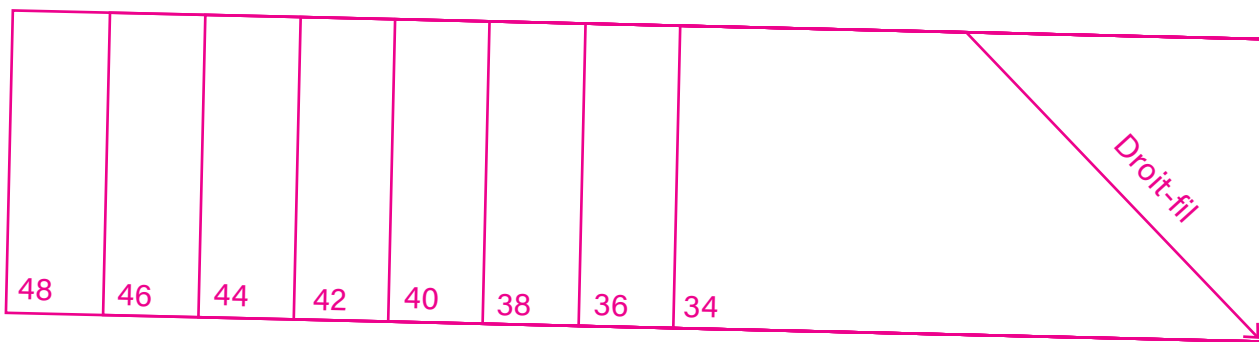
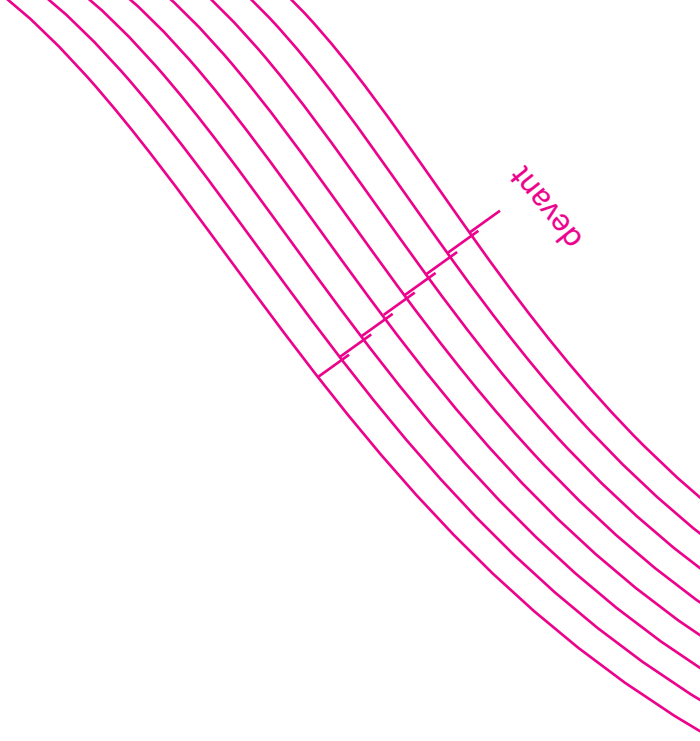

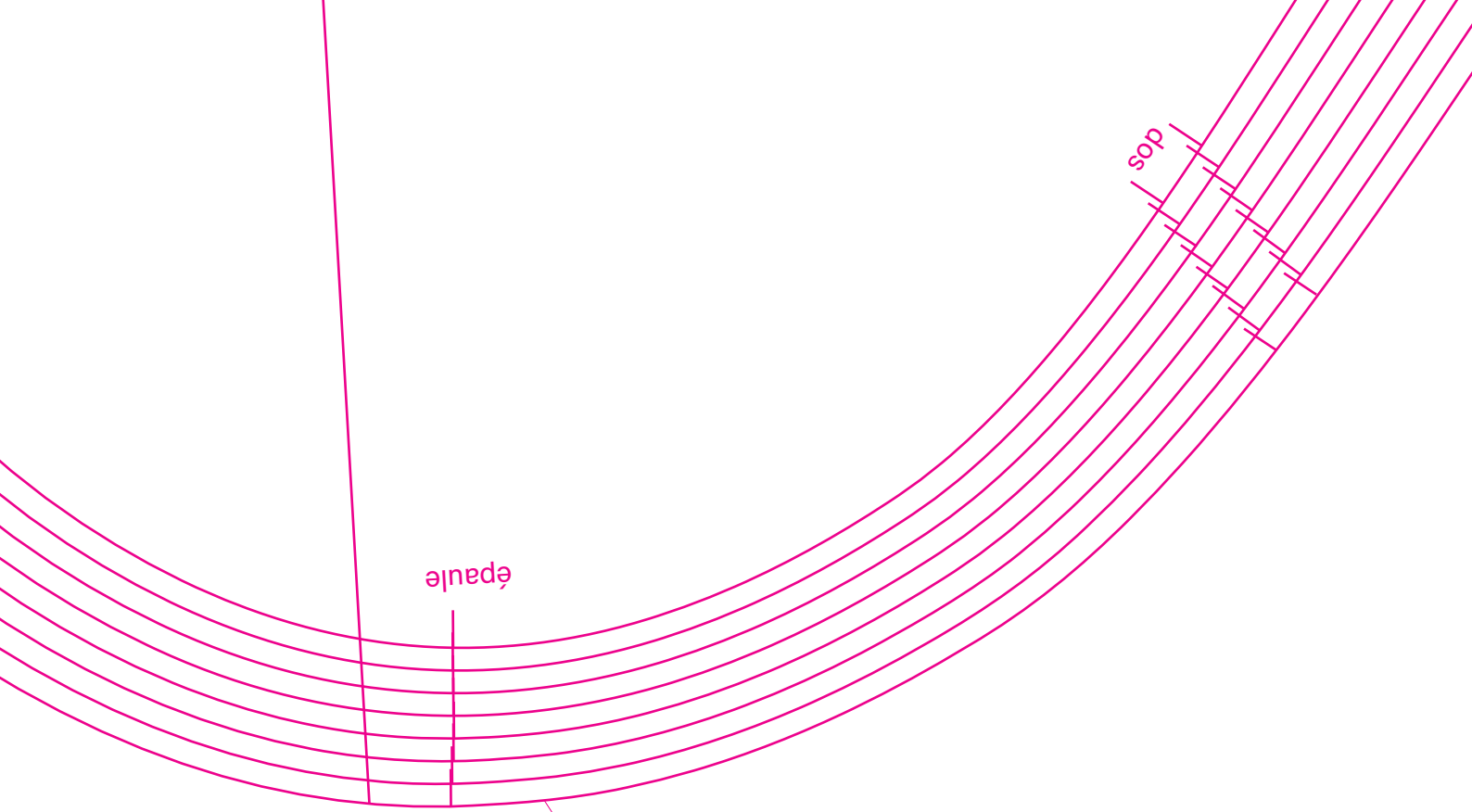

SEVENTIE
MANCHE
À couper 2 X tissu

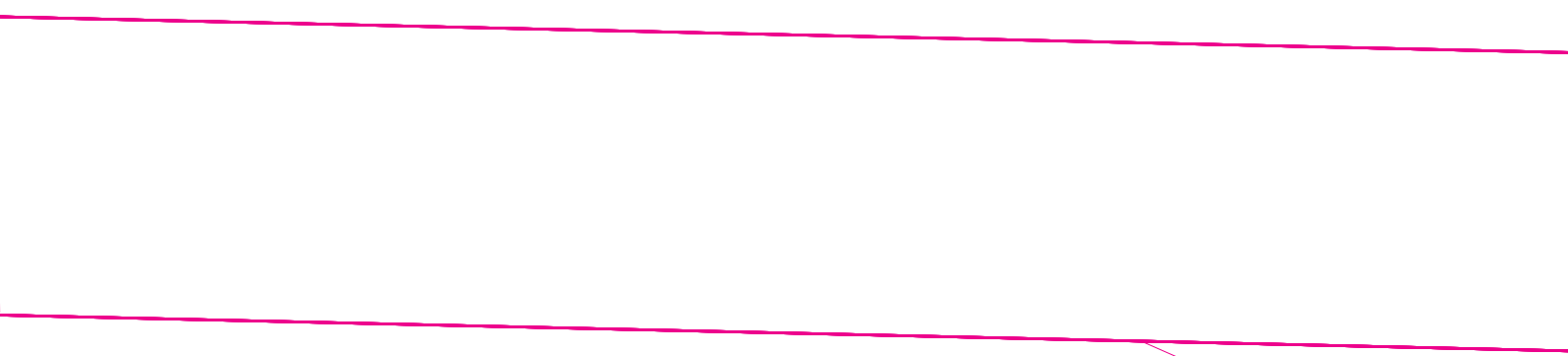

SEVENTIE

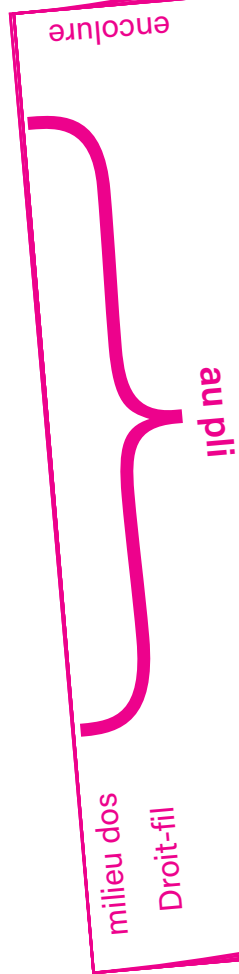

- BIAIS D'ENCOLURE - À couper 1 X tissu



SEVENTH
COL
À couper 1 X tissu
(dans un tissu ép)
À couper 2 X tissu
(dans un tissu fin)



SEVENTIE
PATTE DE BOUTONNAGE

À couper 2 X tissu et 2 X thermocollant

48 ←

34 ←

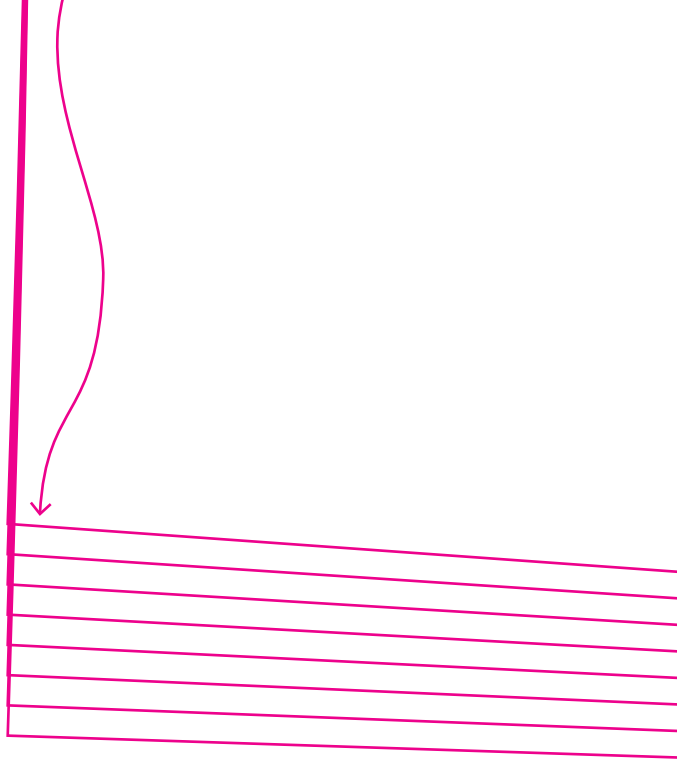

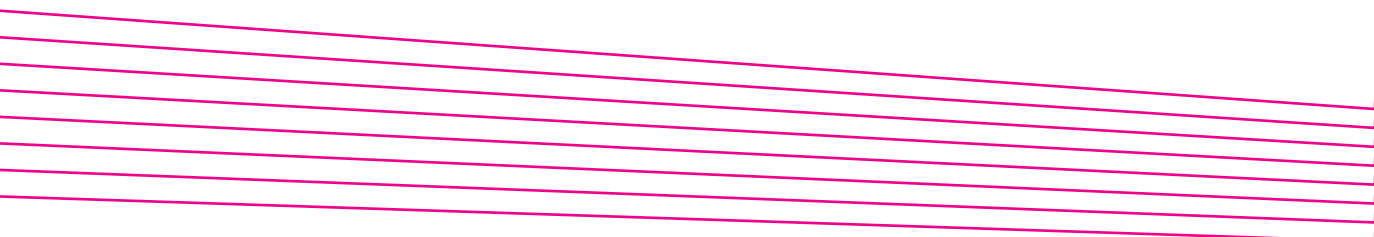

Mon joli dressing

Célia Moreau
@little_c_celia

Carré d'essai
5 x 5 cm

Patron à reconstituer

Nos patrons sont à imprimer sur du papier format A4.
Les pages sont numérotées. Les assembler bord à bord
avec du ruban adhésif. Il y a lieu de prolonger les lignes
d'une page sur l'autre avant de couper les patrons.

Schéma de montage

1	2	3	4	5	6	7	8
9	10	11	12	13	14	15	16
17	18	19	20	21	22	23	24
25	26	27	28	29	30	31	32

48 46 44 42 40 38 36 34 dos

**PRETTY
BRACELET
DE MANCHE**
À couper 2 X tissu

devant 34 36 38 40 42 44 46 48

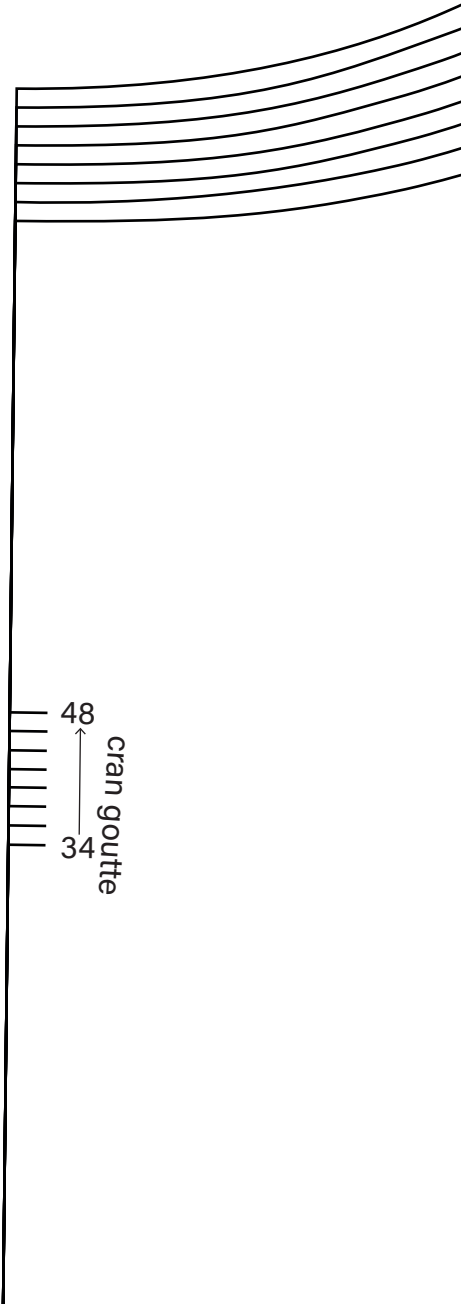
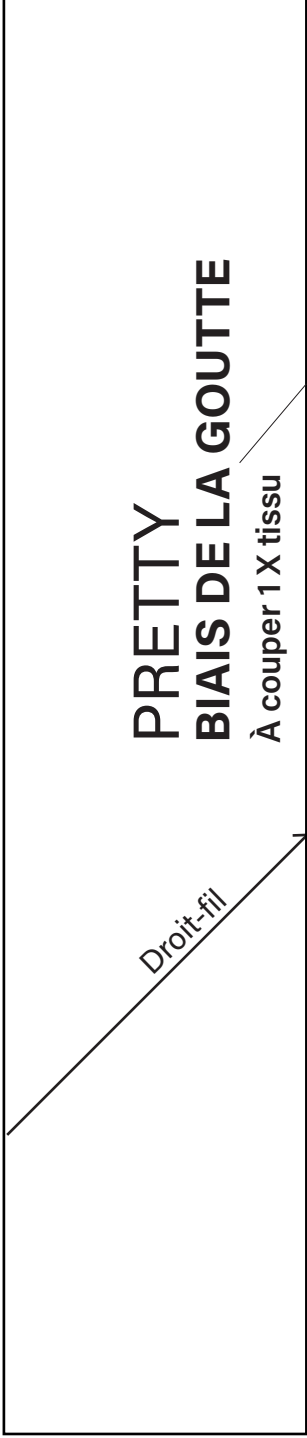

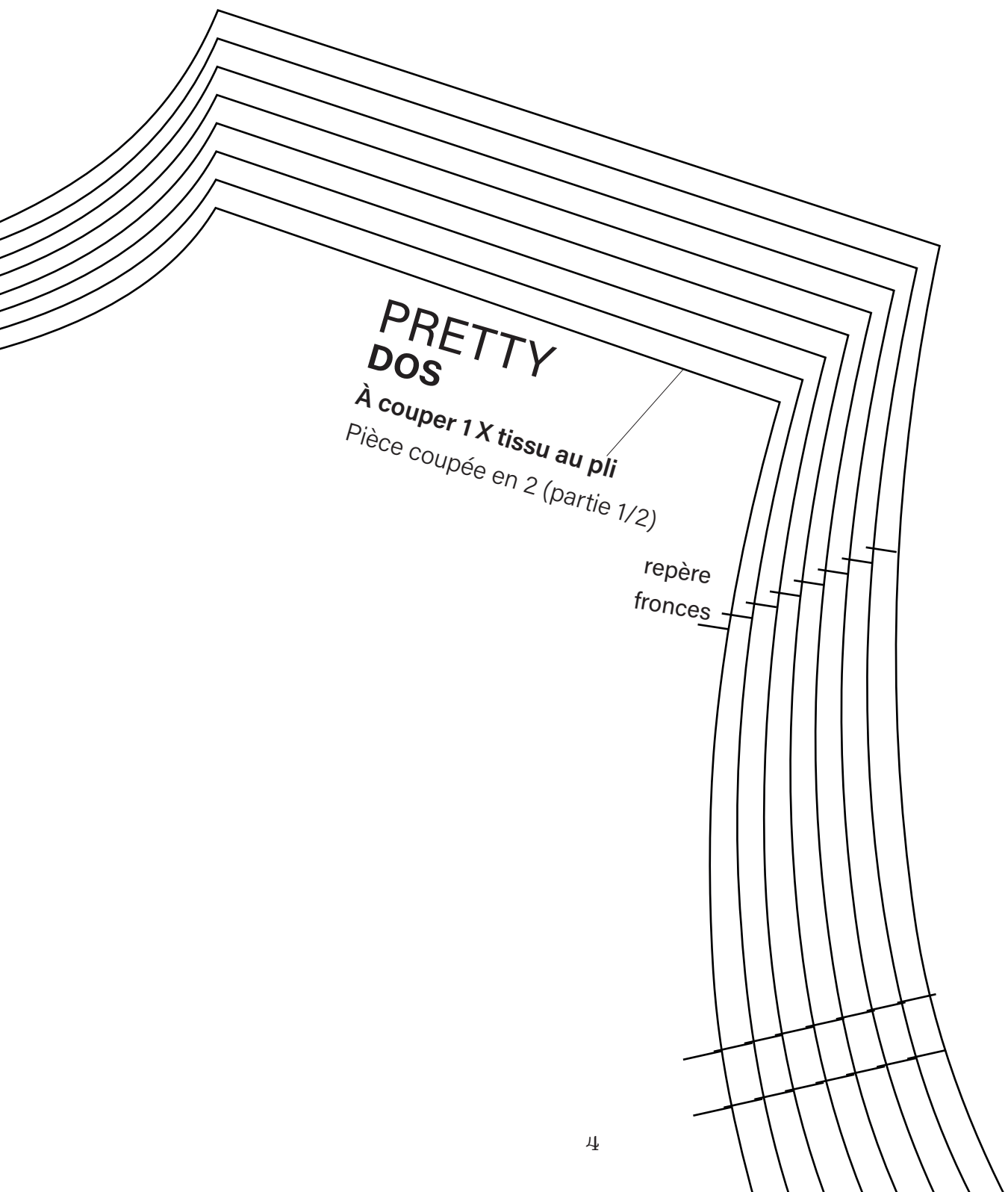

PRETTY DOS

À couper 1 X tissu au pli
Pièce coupée en 2 (partie 1/2)

repère
fronces

PRETTY - BRIDE

À couper 1 X tissu

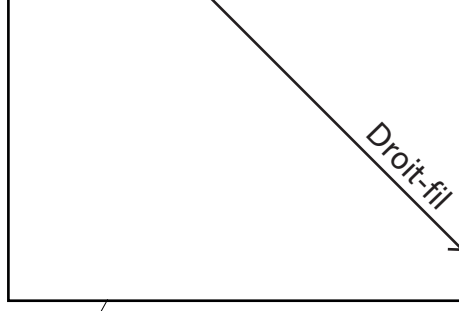

longueur robe

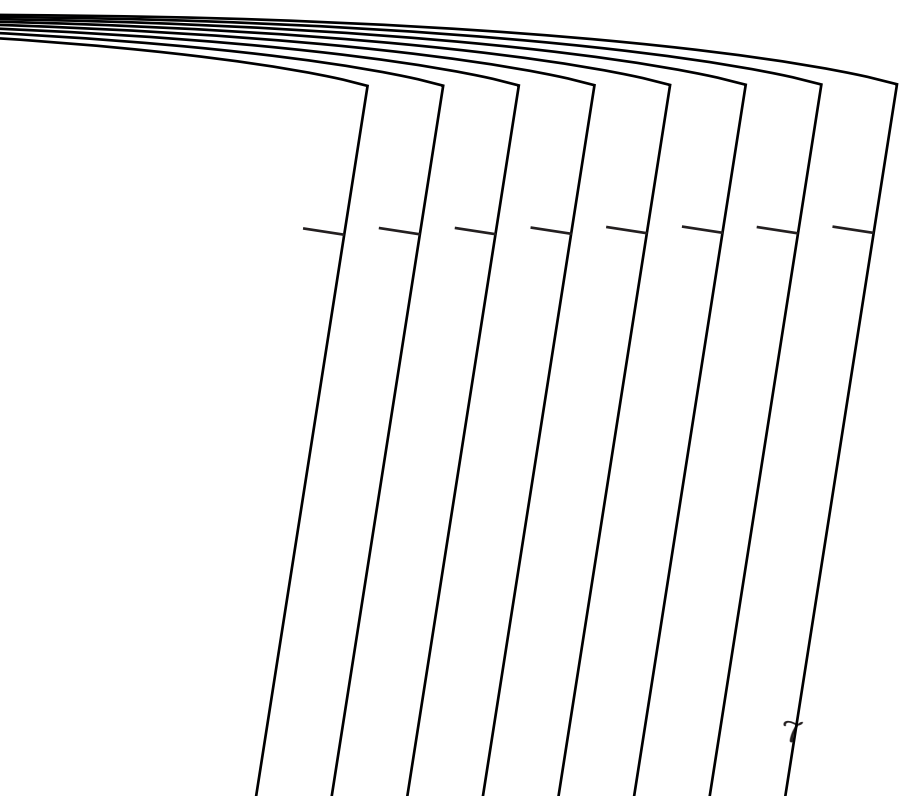

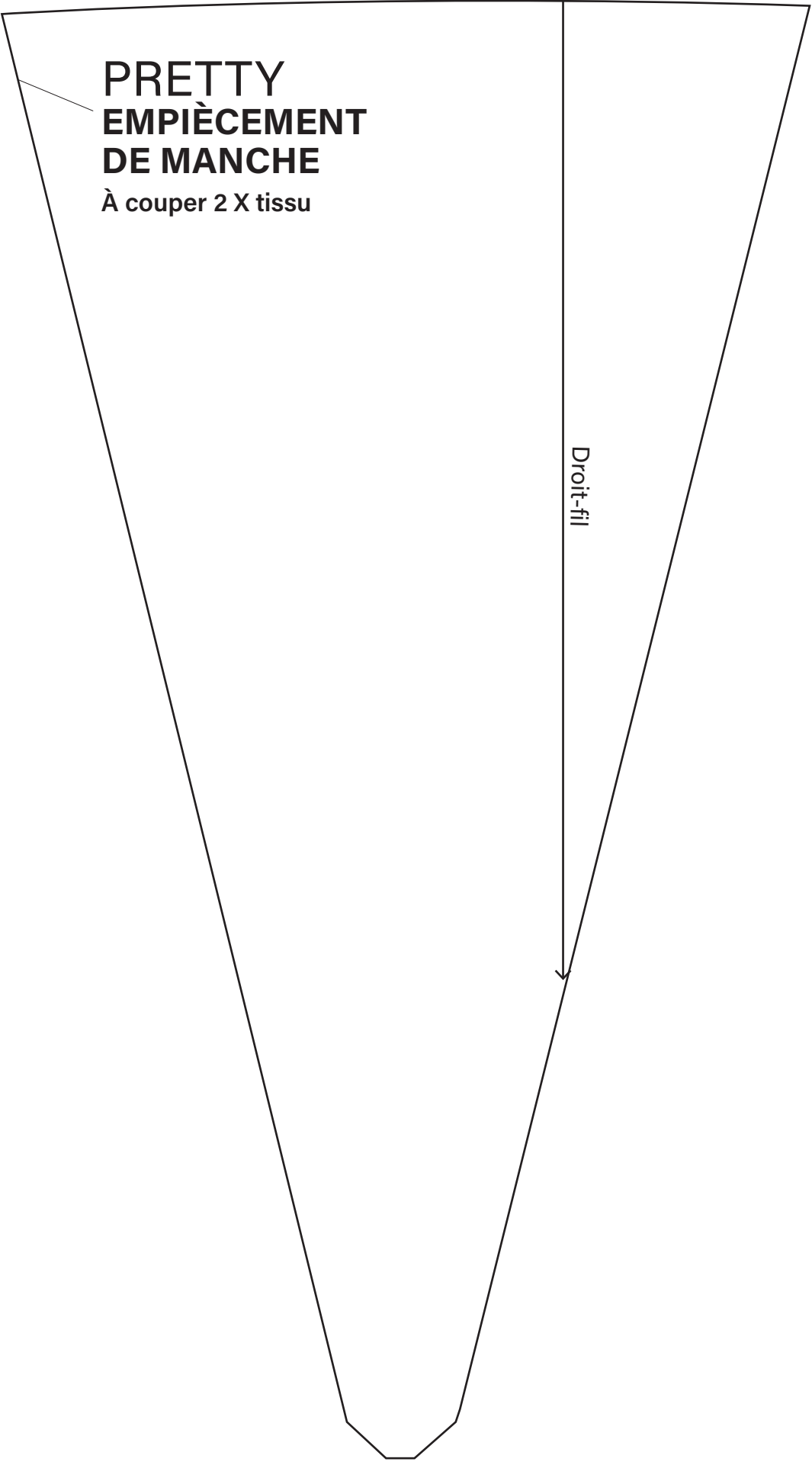

**PRETTY
EMPIÈCEMENT
DE MANCHE**

À couper 2 X tissu

Droit-fil

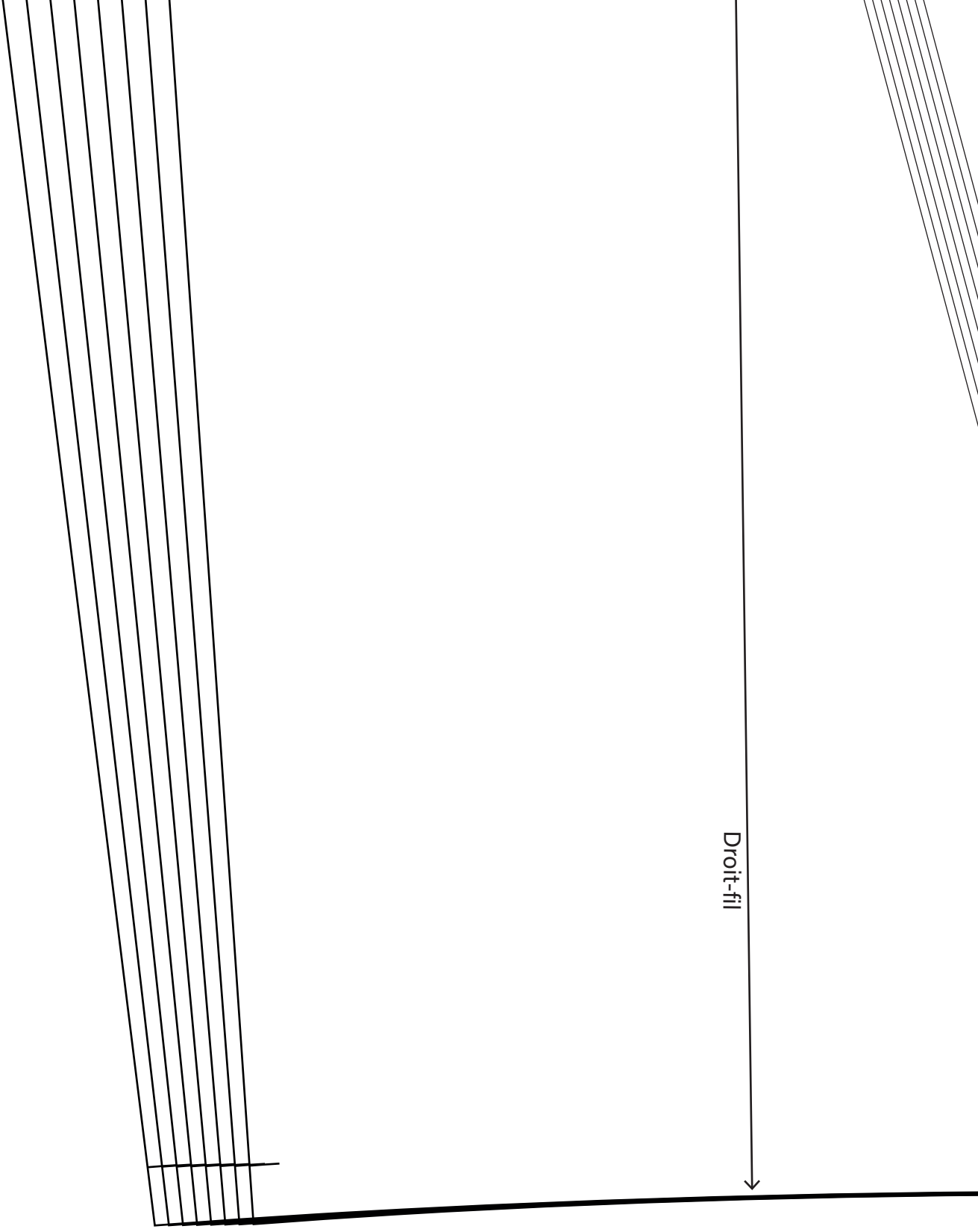

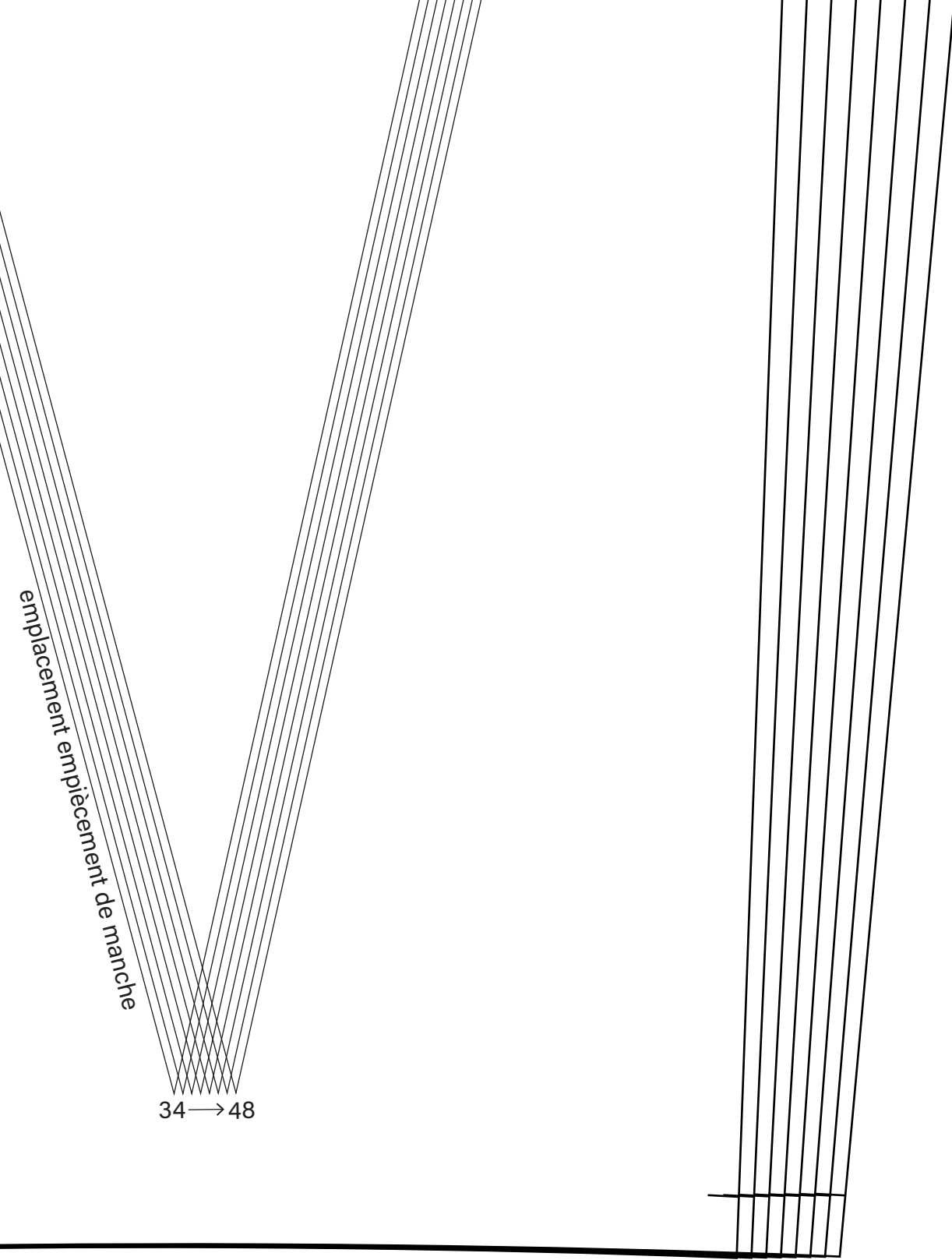

Droit-fil

milieu dos



au pli



PRETTY DOS

À couper 1 X tissu au pli

42 44 46 48

longueur blouse

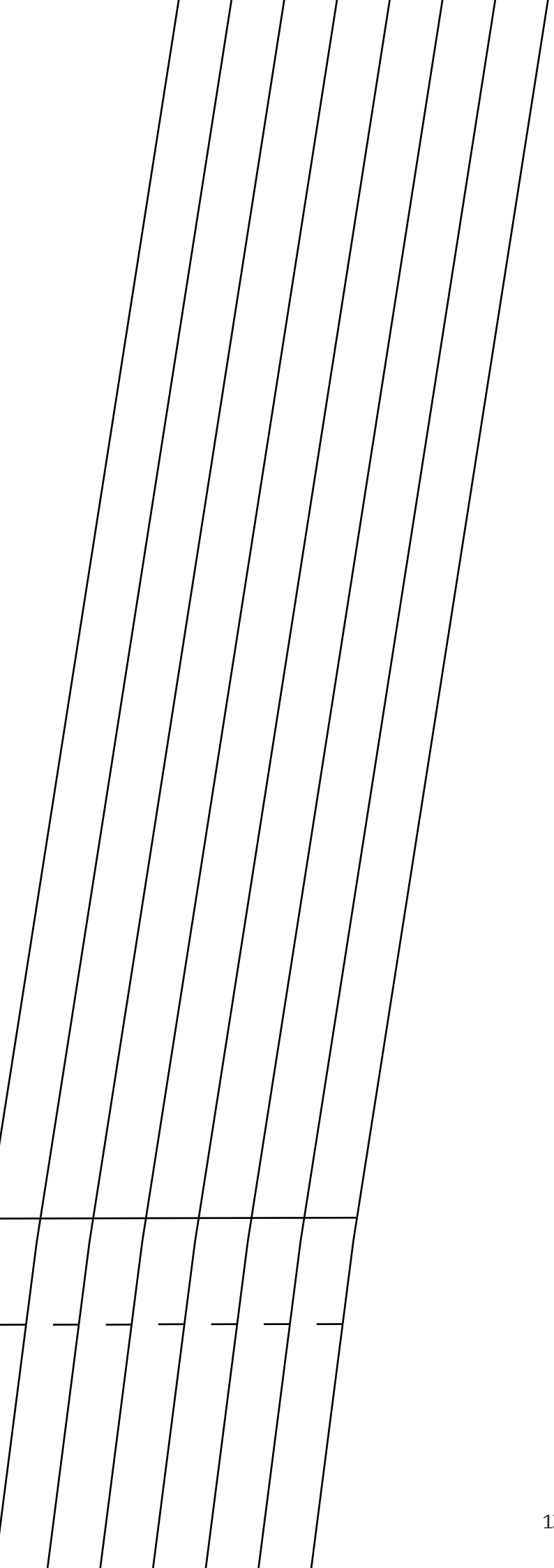

**PRETTY
BIAIS D'ENCOLURE**

À couper 1 X tissu



fronces

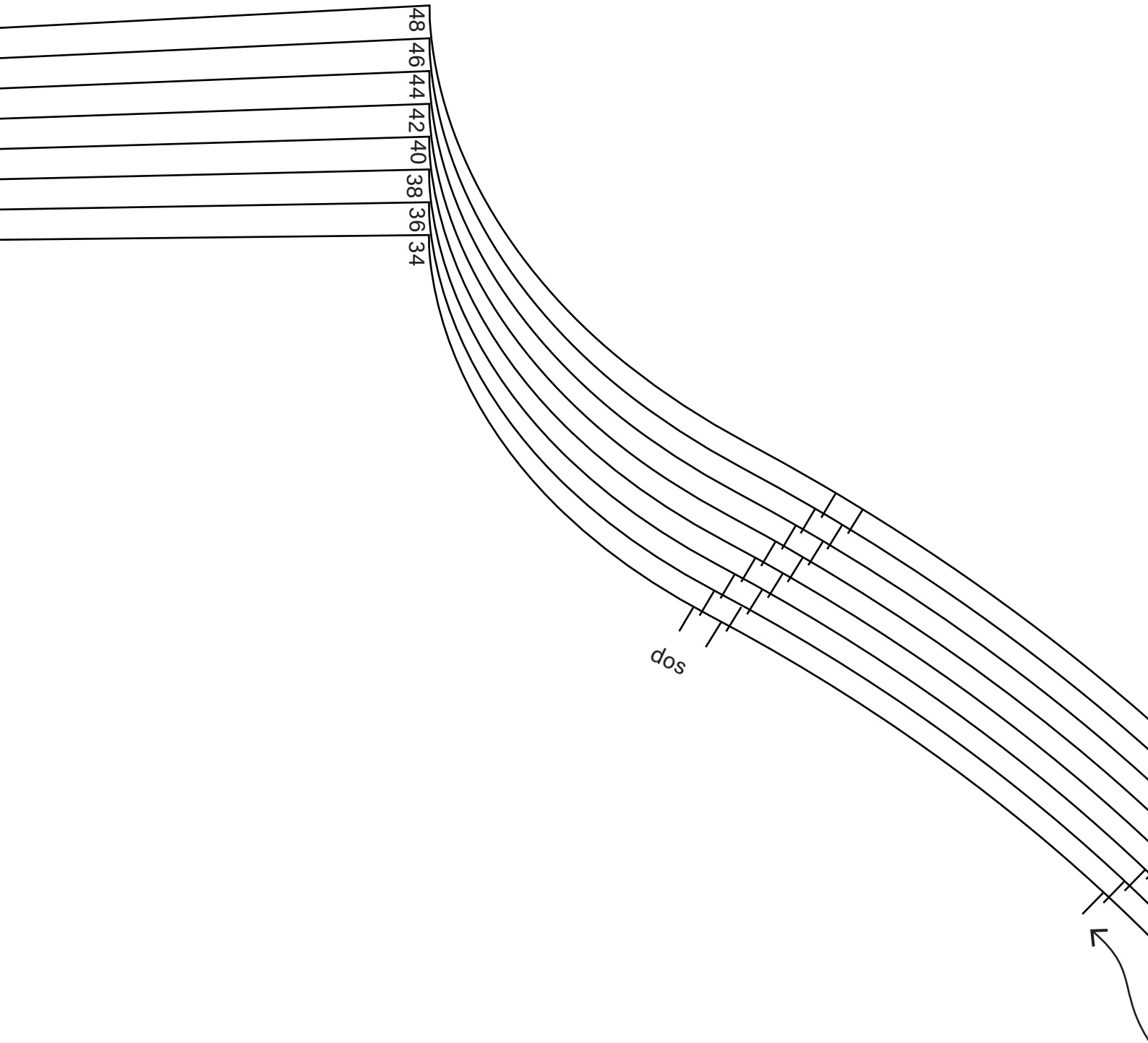

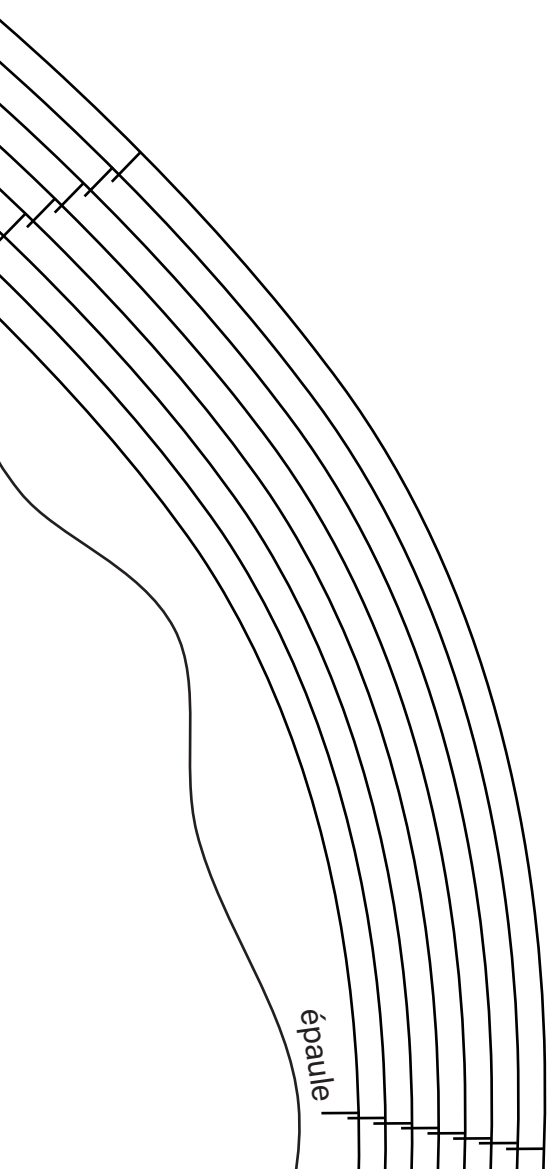

longueur blouse

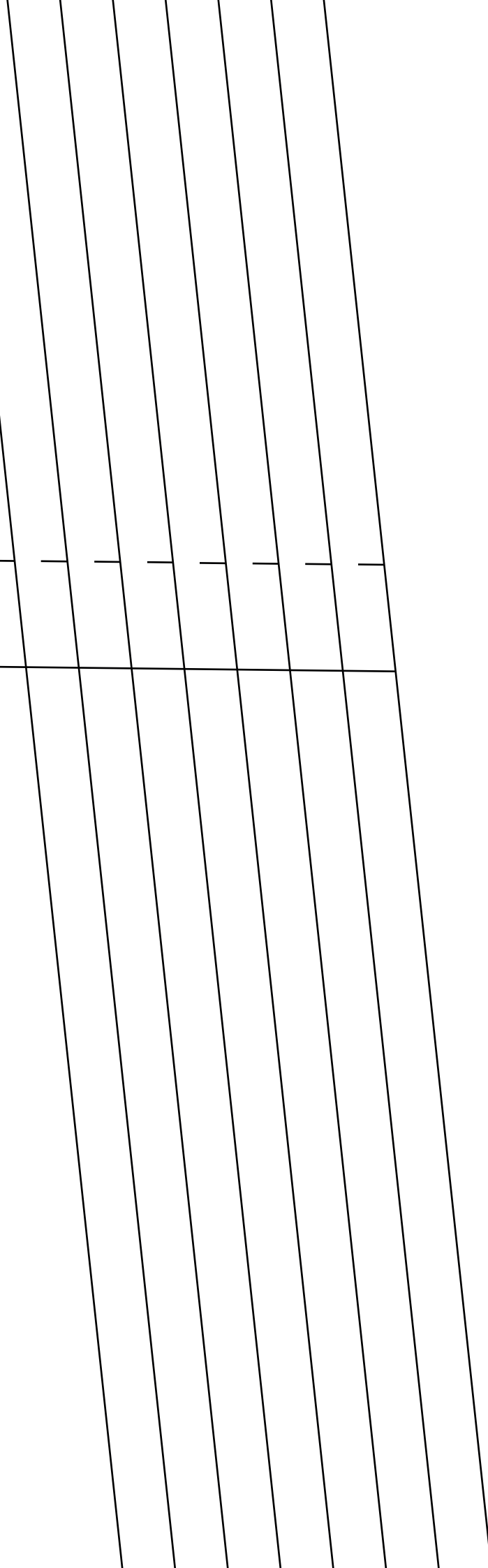

Droit-fil milieu



au pli



**PRETTY
DEVANT**

À couper 1 X tissu au pli

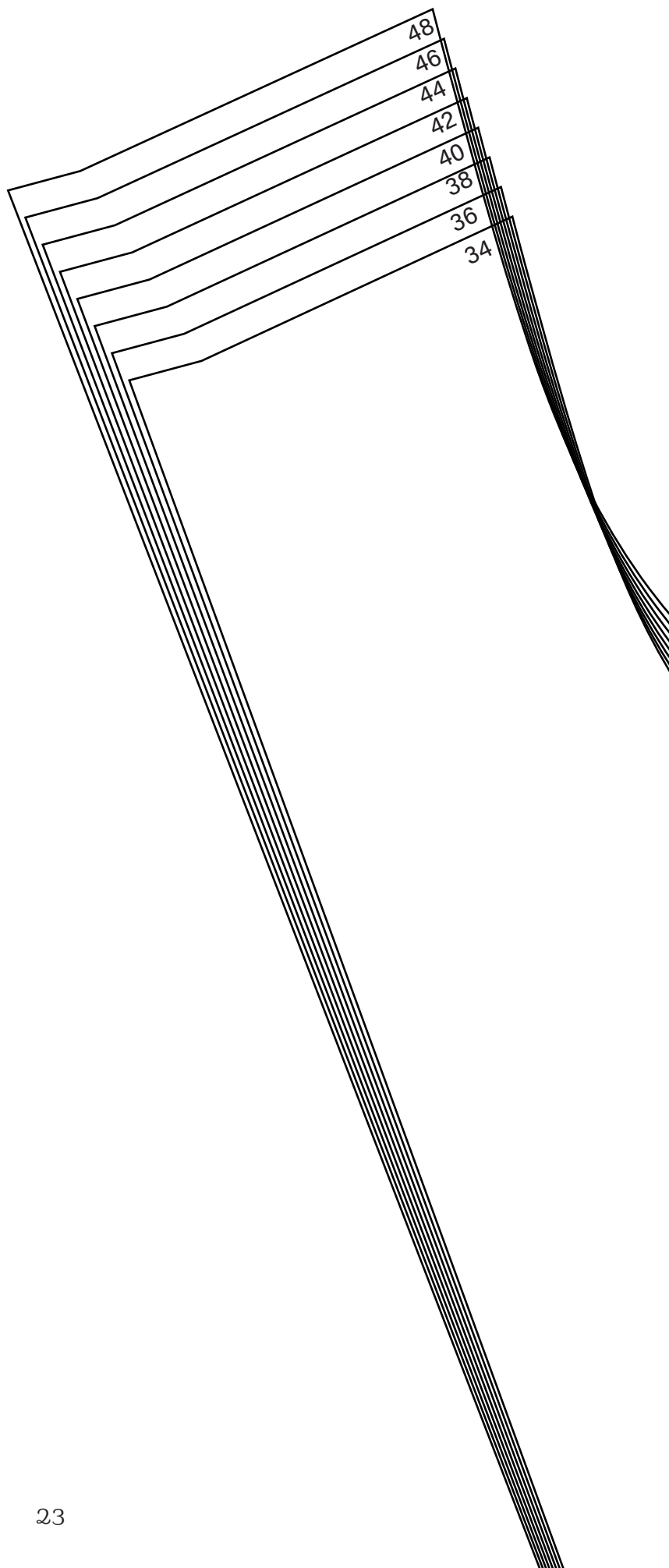
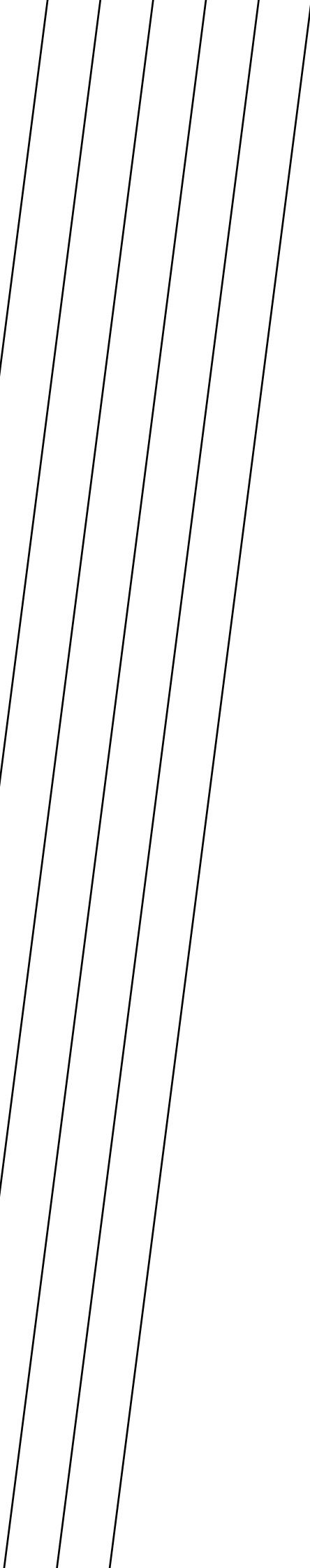

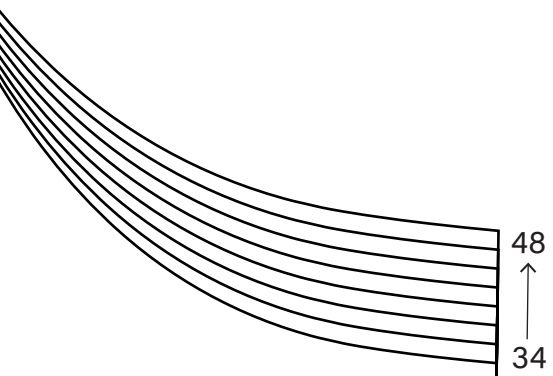

Droit-fil milieu devant

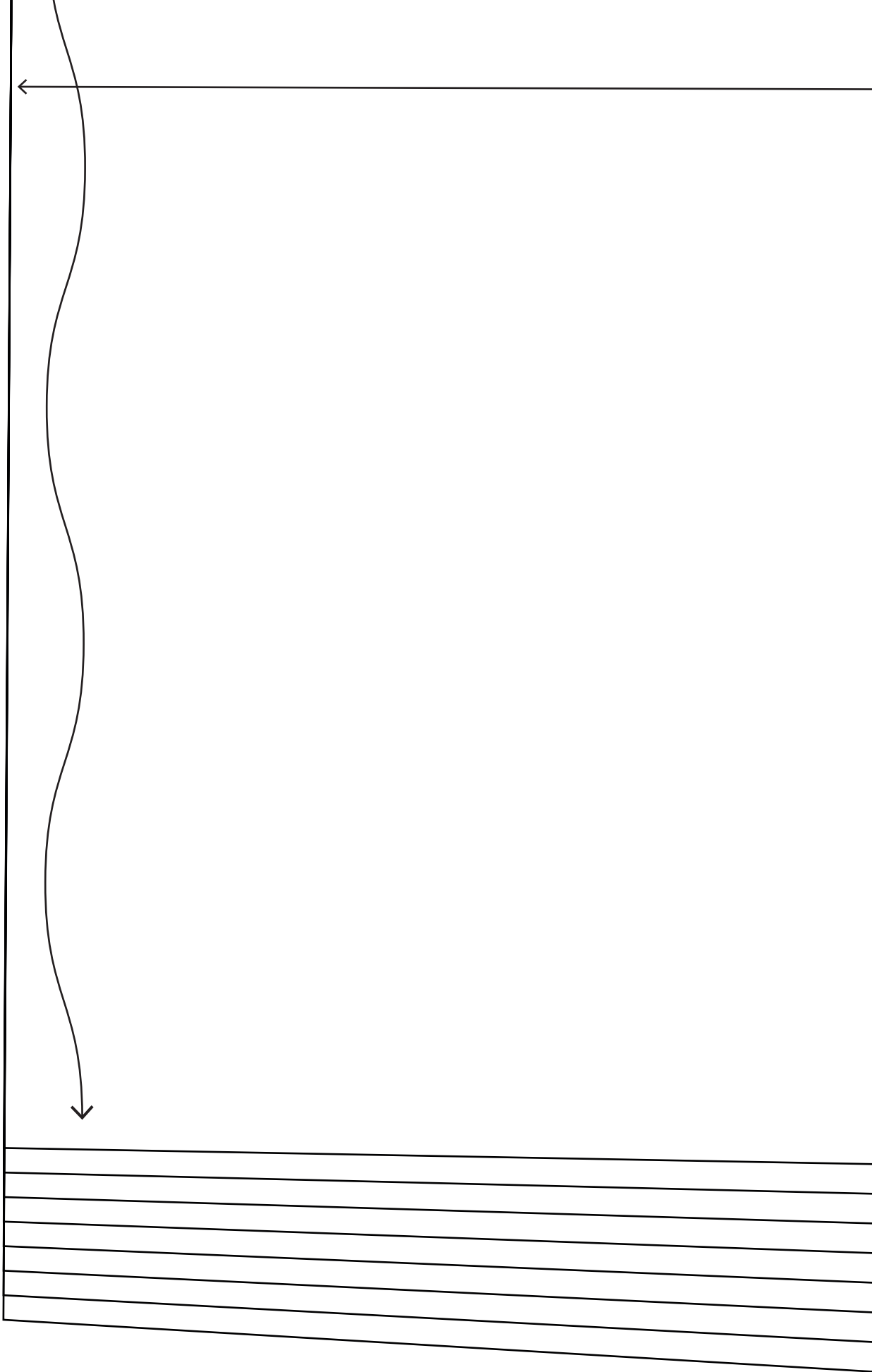

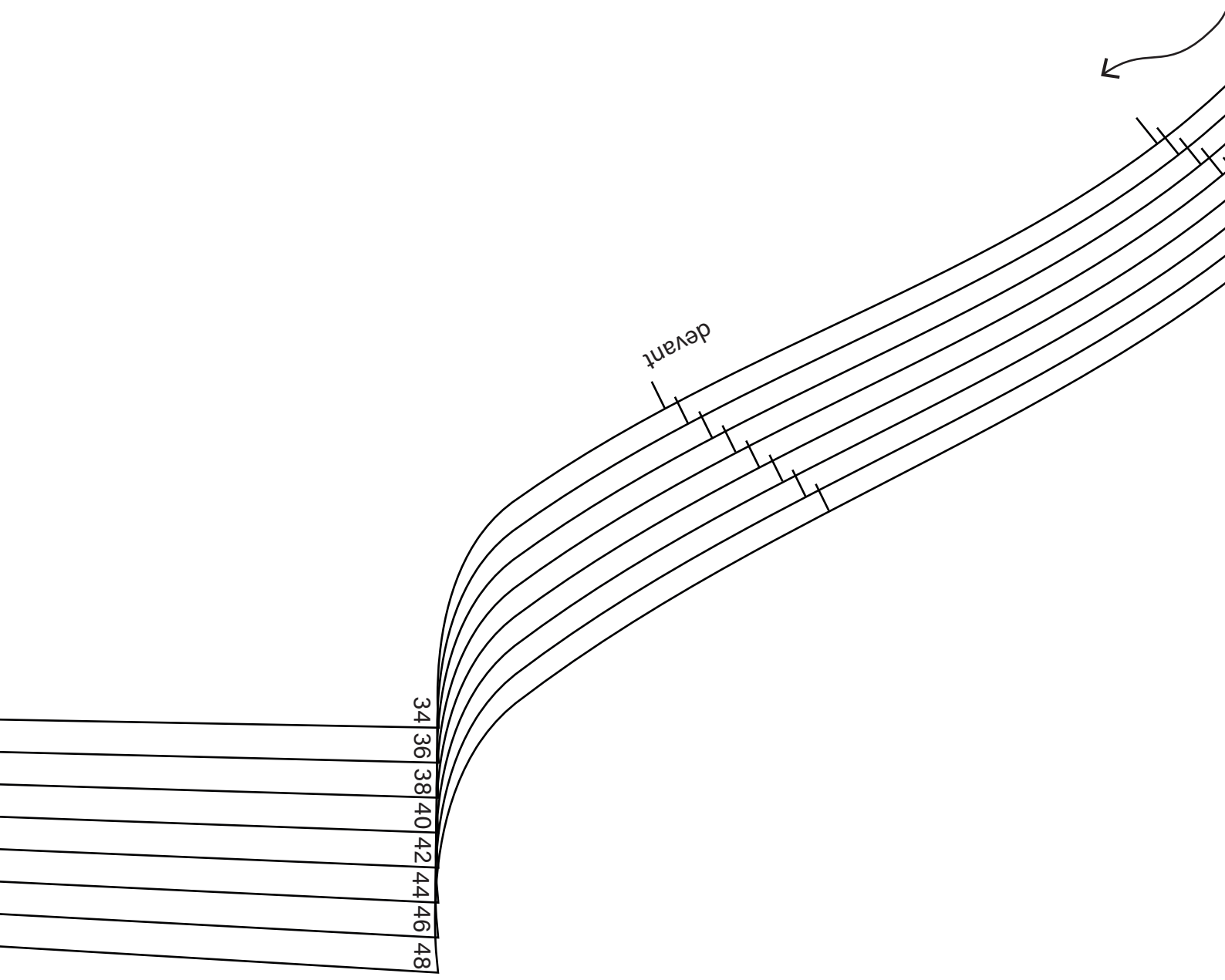

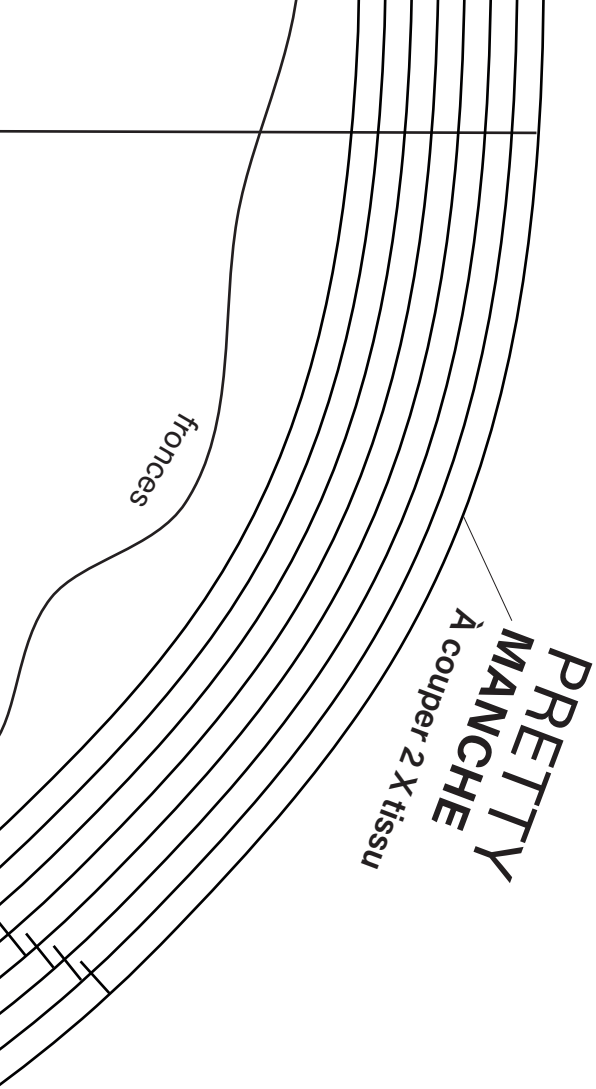

longueu

ur robe

devant

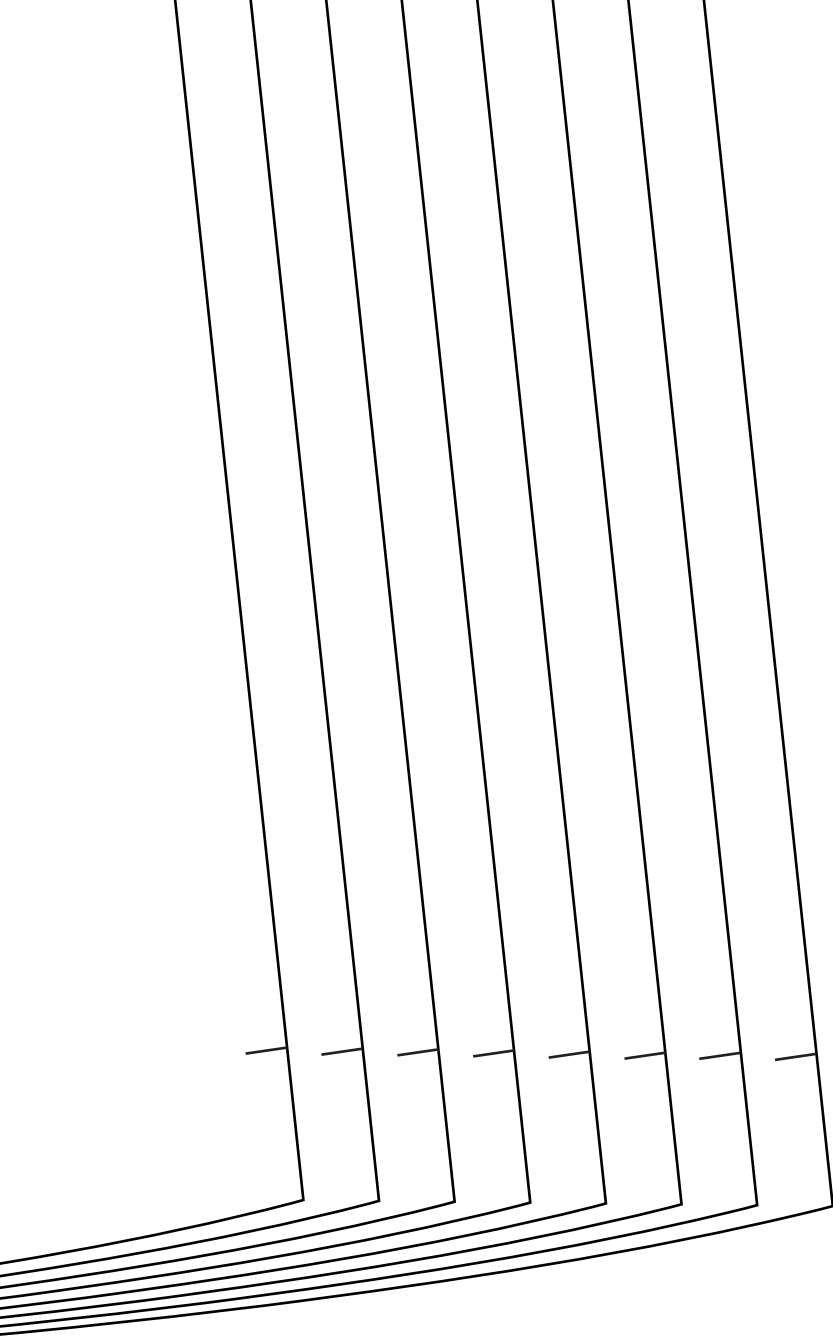

34
↓
48

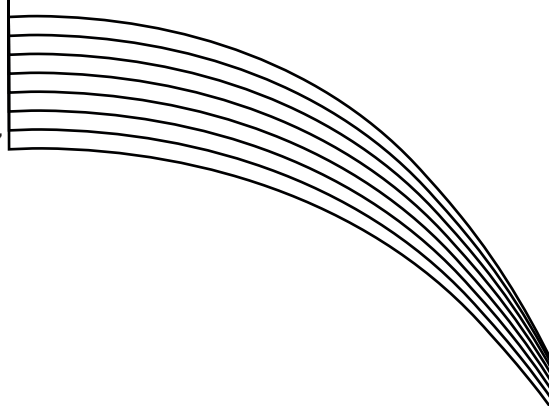

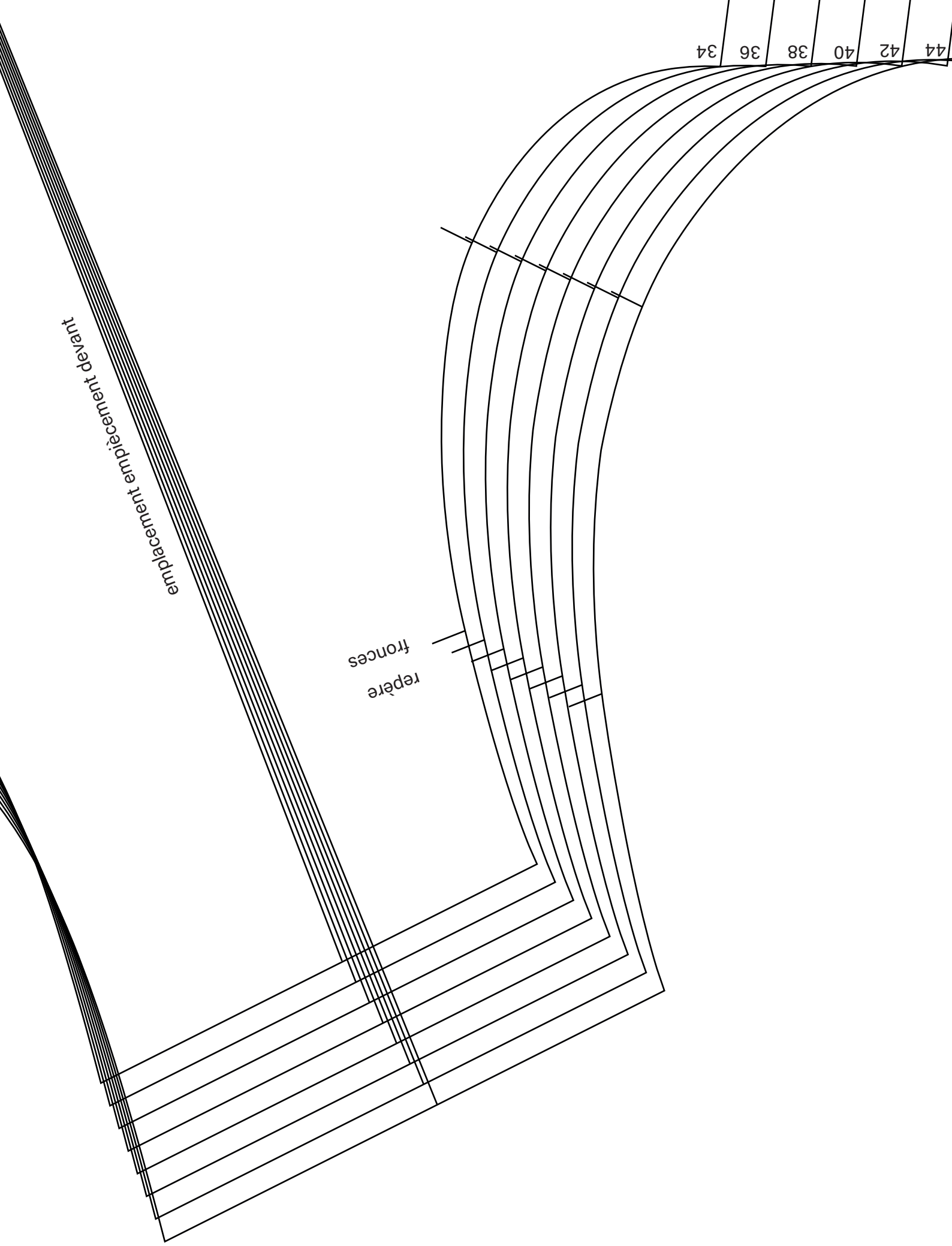

48	46
----	----

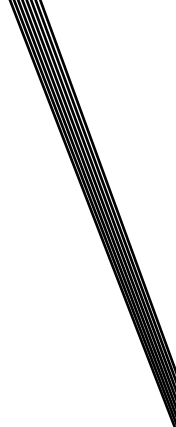

34	36	38	40	42	44	46	48
----	----	----	----	----	----	----	----

Droit-fil

**PRETTY
EMPIÈCEMENT
DEVANT**

À couper 1 X tissu au pli

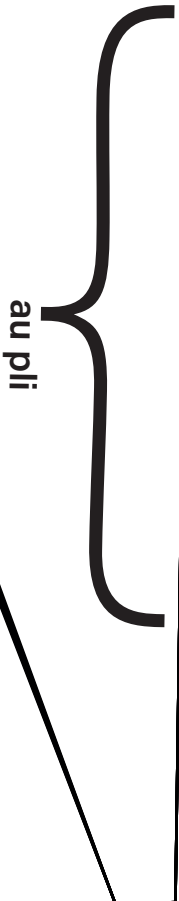

Mon joli dressing

Célia Moreau
@little_c_celia

Carré d'essai
5 x 5 cm

Patron à reconstituer

Nos patrons sont à imprimer sur du papier format A4.
Les pages sont numérotées. Les assembler bord à bord
avec du ruban adhésif. Il y a lieu de prolonger les lignes
d'une page sur l'autre avant de couper les patrons.

Schéma de montage

1	2	3	4	5	6	7
8	9	10	11	12	13	14
15	16	17	18	19	20	
21	22	23	24	25	26	

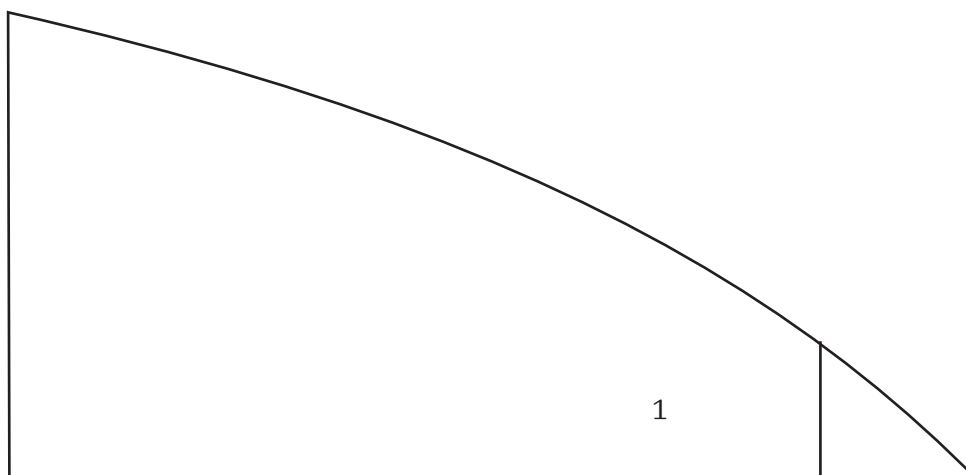



repère
poche

POLLY
JAMBE DEVANT
À couper 2 X tissu

ligne de pliure pour surpiqûre (facultatif)

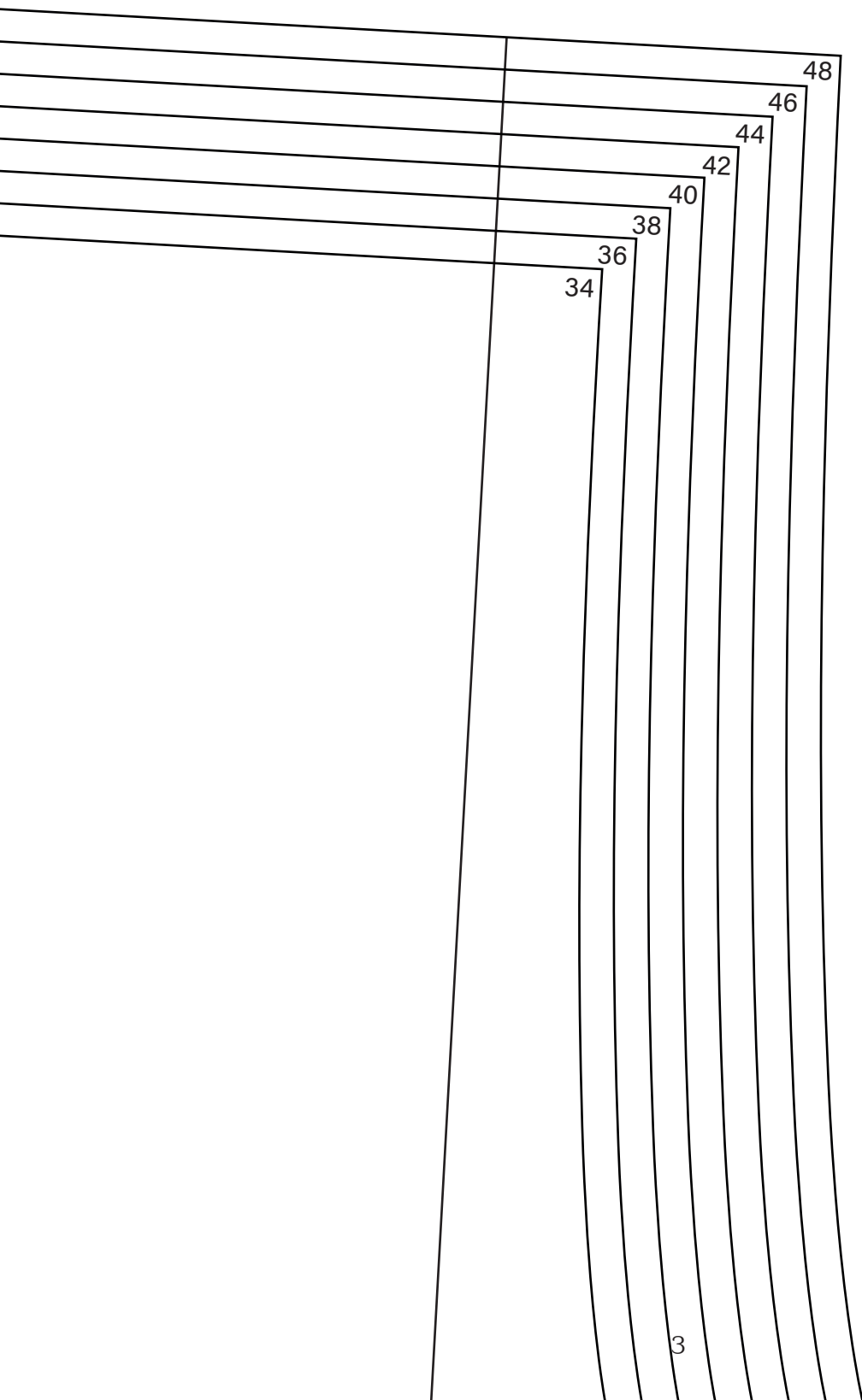

48

46

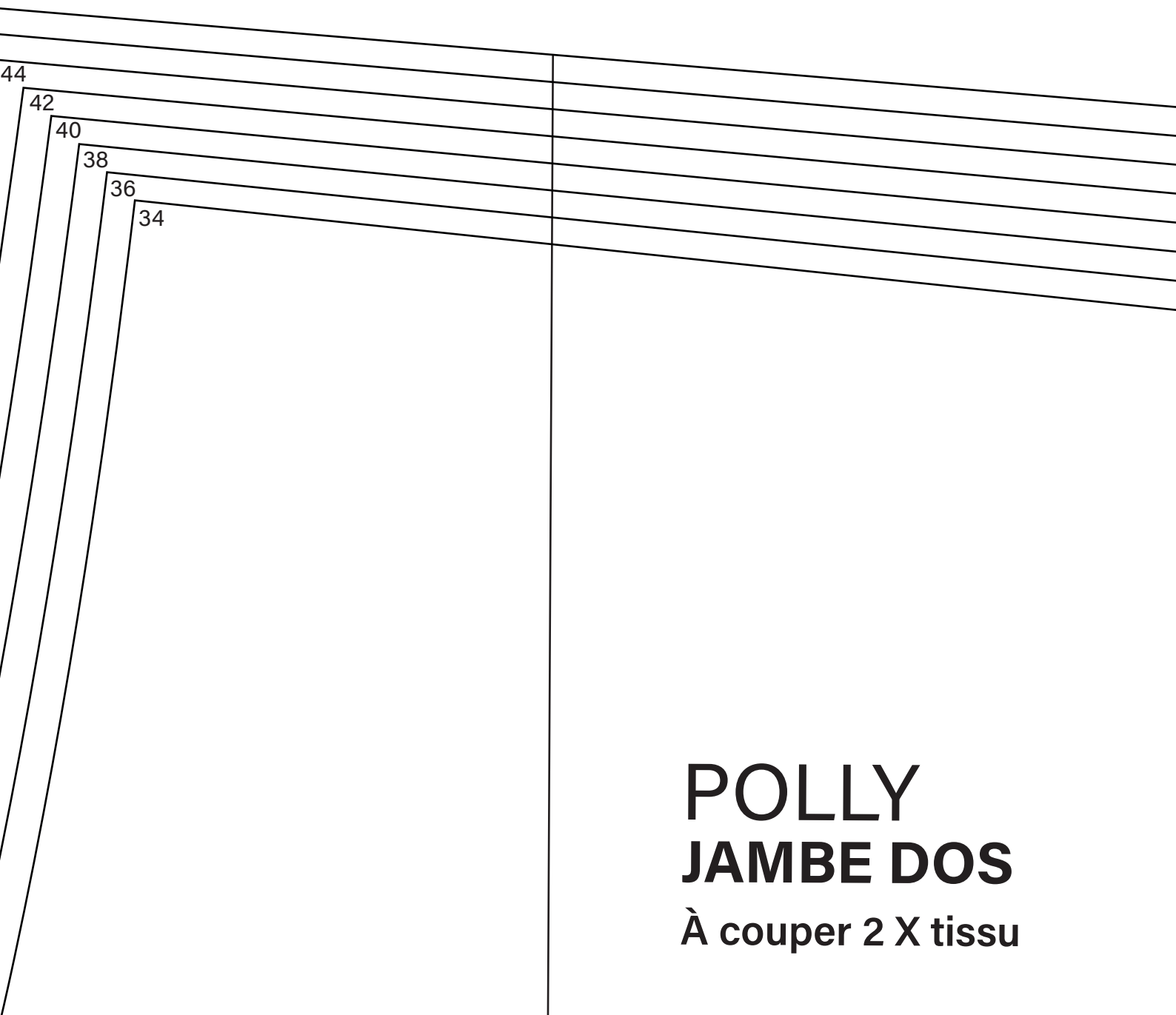

POLLY
JAMBE DOS
À couper 2 X tissu

A technical drawing showing the corner of a pocket. It consists of several parallel lines representing the pocket's depth and the reference line. The text 'repère poche' is positioned to the left of the lines, with a horizontal line pointing to the innermost parallel line.

repère
poche

ligne de pliure

Droit-fil

POLLY POCHE

À couper 4 X tissu

48
46
44
42
40
38
36
34

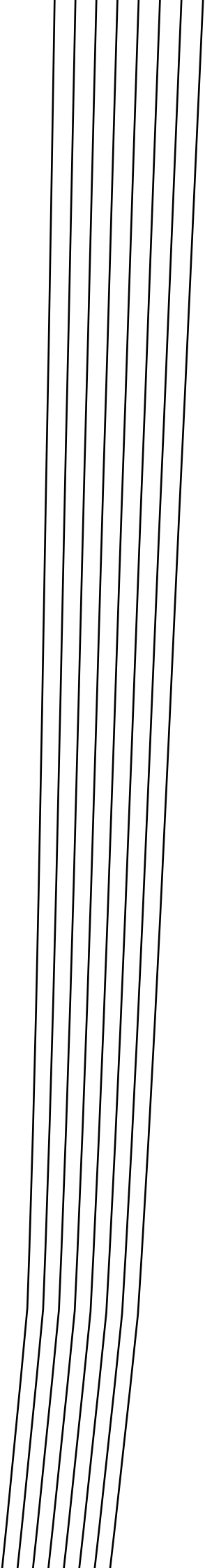

Droit-fil

34 36 38 40 42 44 46 48

48 46 44 42 40 38 36 34

**POLLY
LIEN À NOUVER**
À couper 2 X tissu

48		
46		
44		
42		
40		
38		
36		
34	Droit-fil	

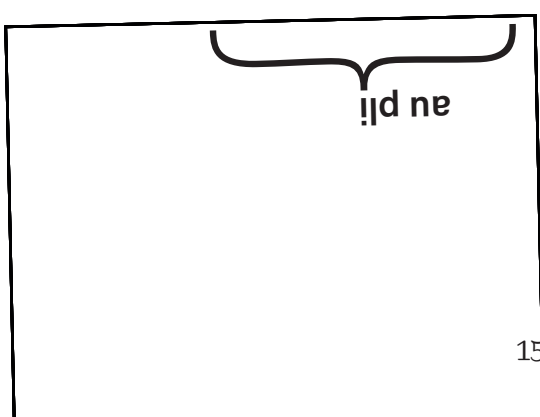
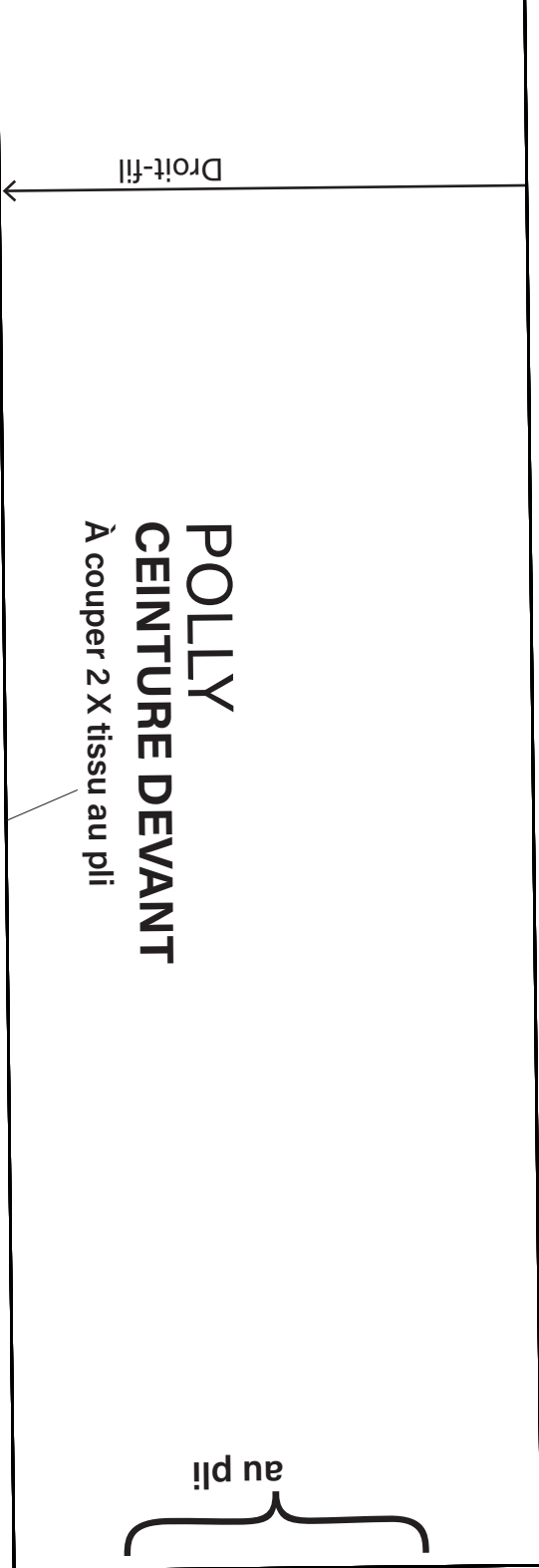

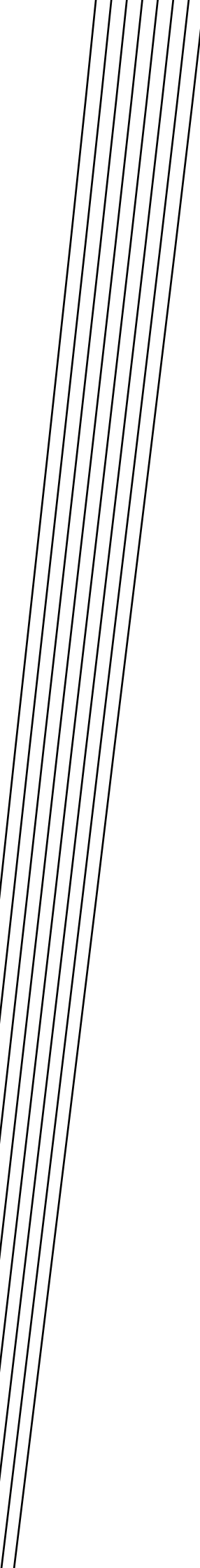

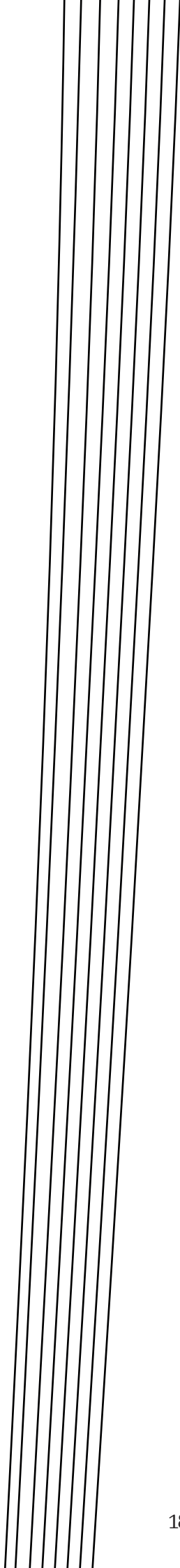

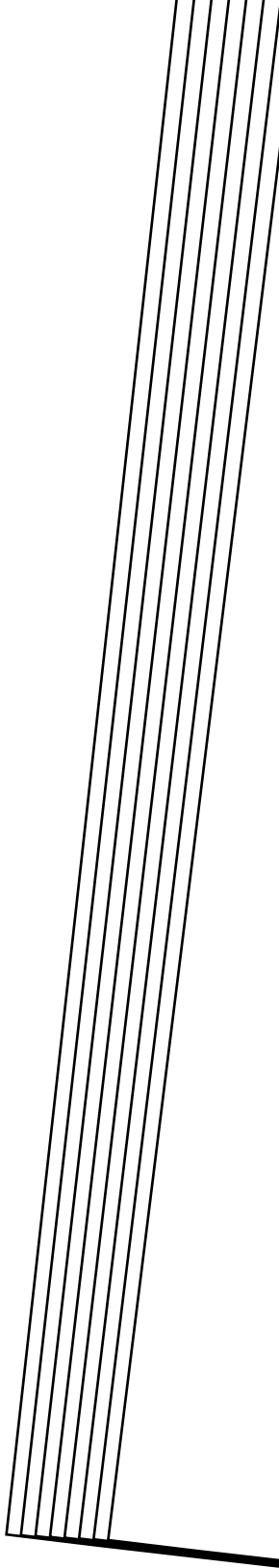

POLLY CEINTURE DOS

À couper 2 X tissu au pli

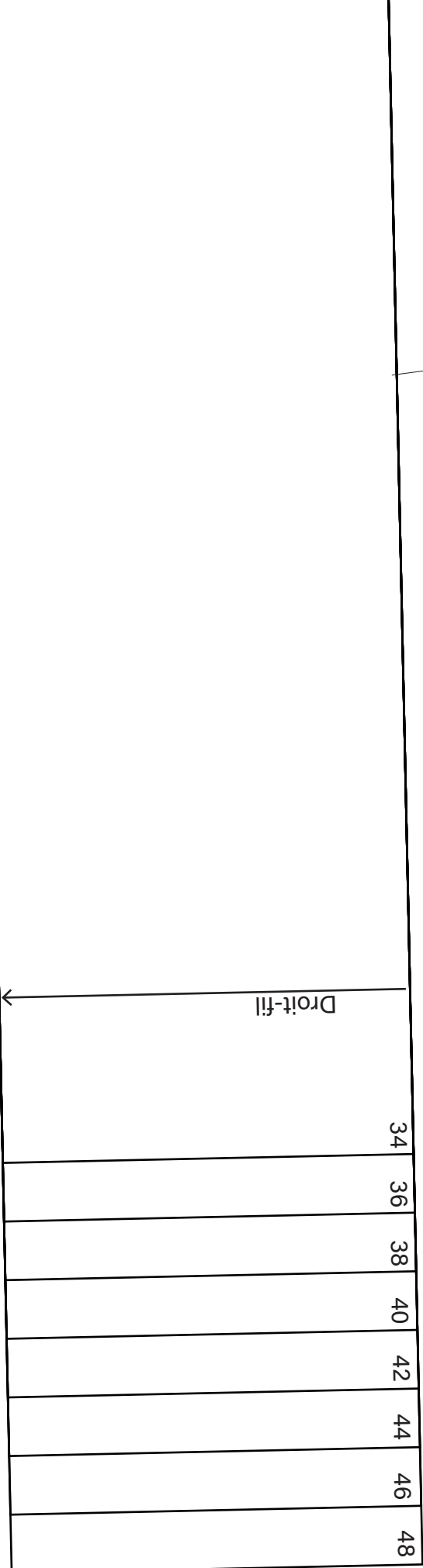

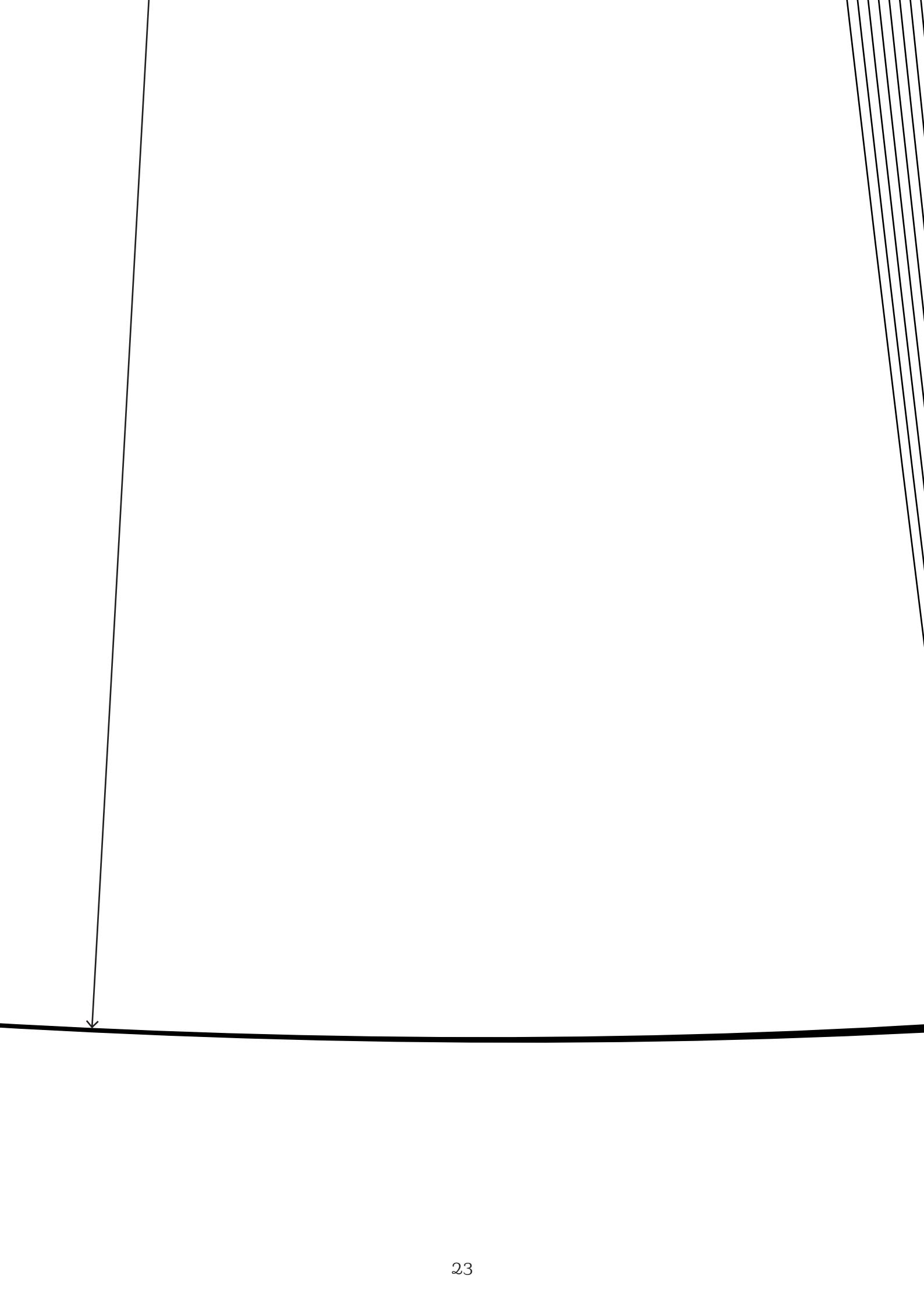

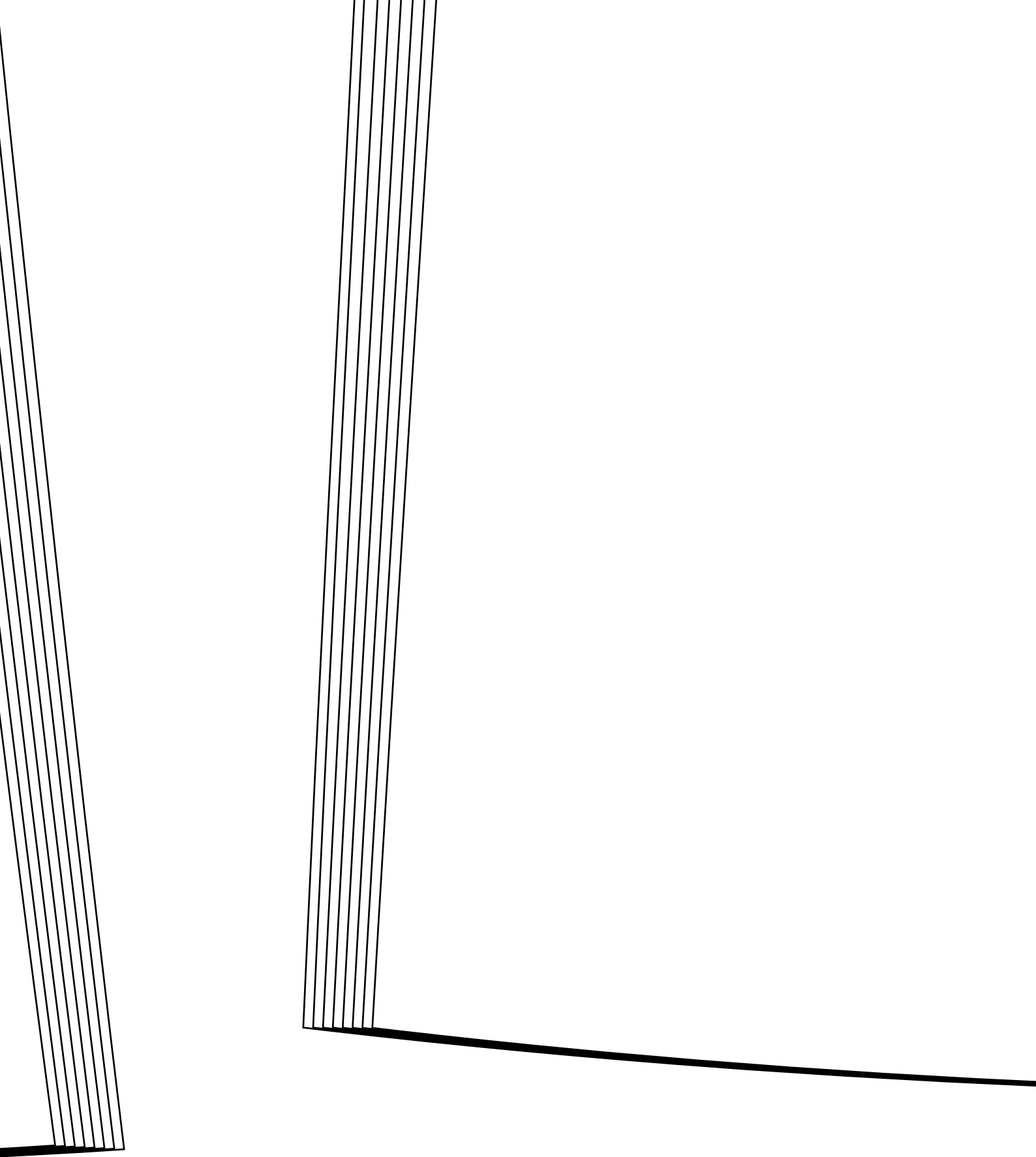



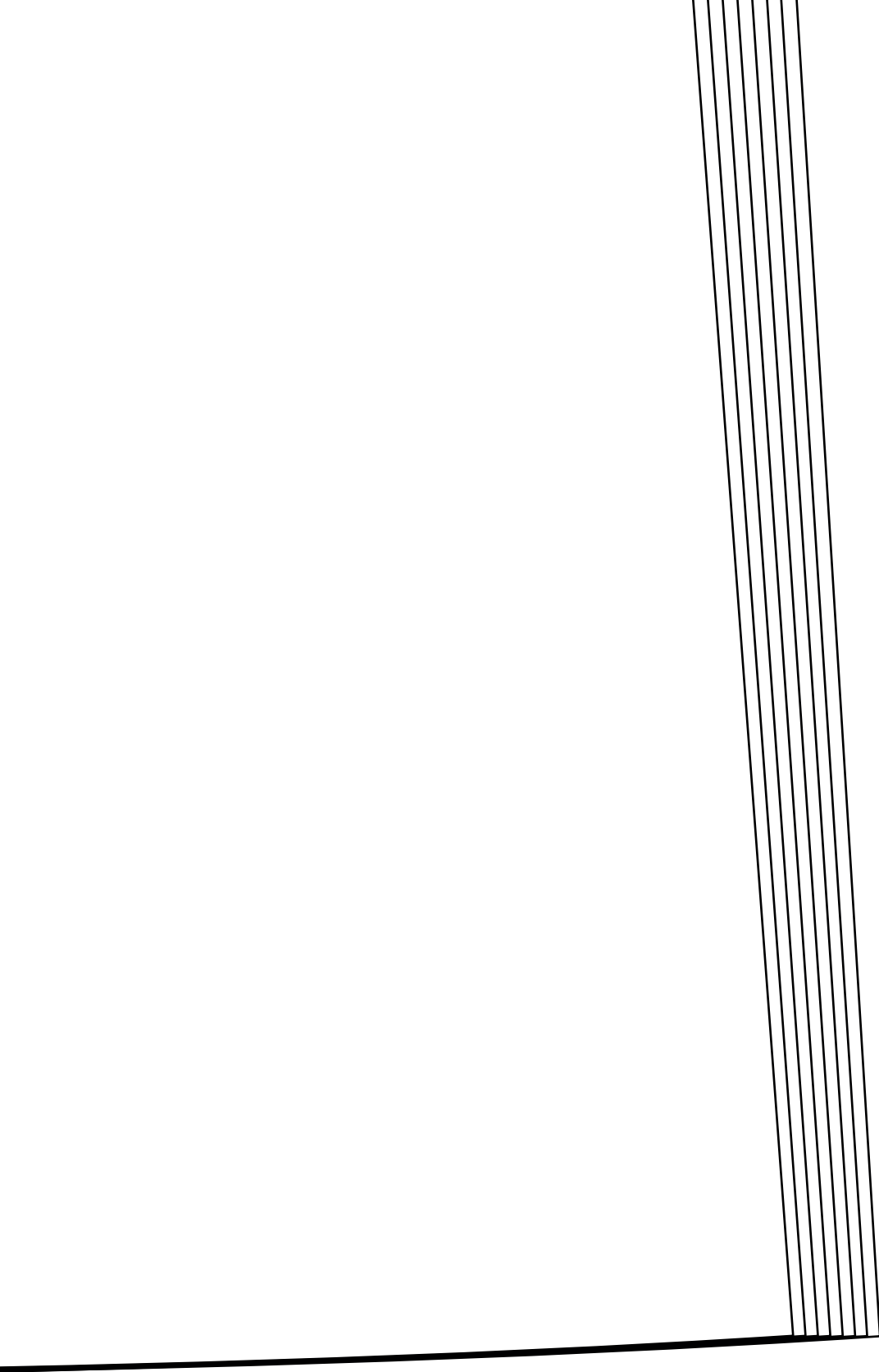

Mon joli dressing

Célia Moreau
@little_c_celia

Carré d'essai
5 x 5 cm

Patron à reconstituer

Nos patrons sont à imprimer sur du papier format A4.
Les pages sont numérotées. Les assembler bord à bord
avec du ruban adhésif. Il y a lieu de prolonger les lignes
d'une page sur l'autre avant de couper les patrons.

Schéma de montage

1	2	3	4	5	6	7	8
9	10	11	12	13	14	15	16
17	18	19	20	21	22	23	24
25	26	27	28	29	30	31	32
33	34	35					
36	37	38					

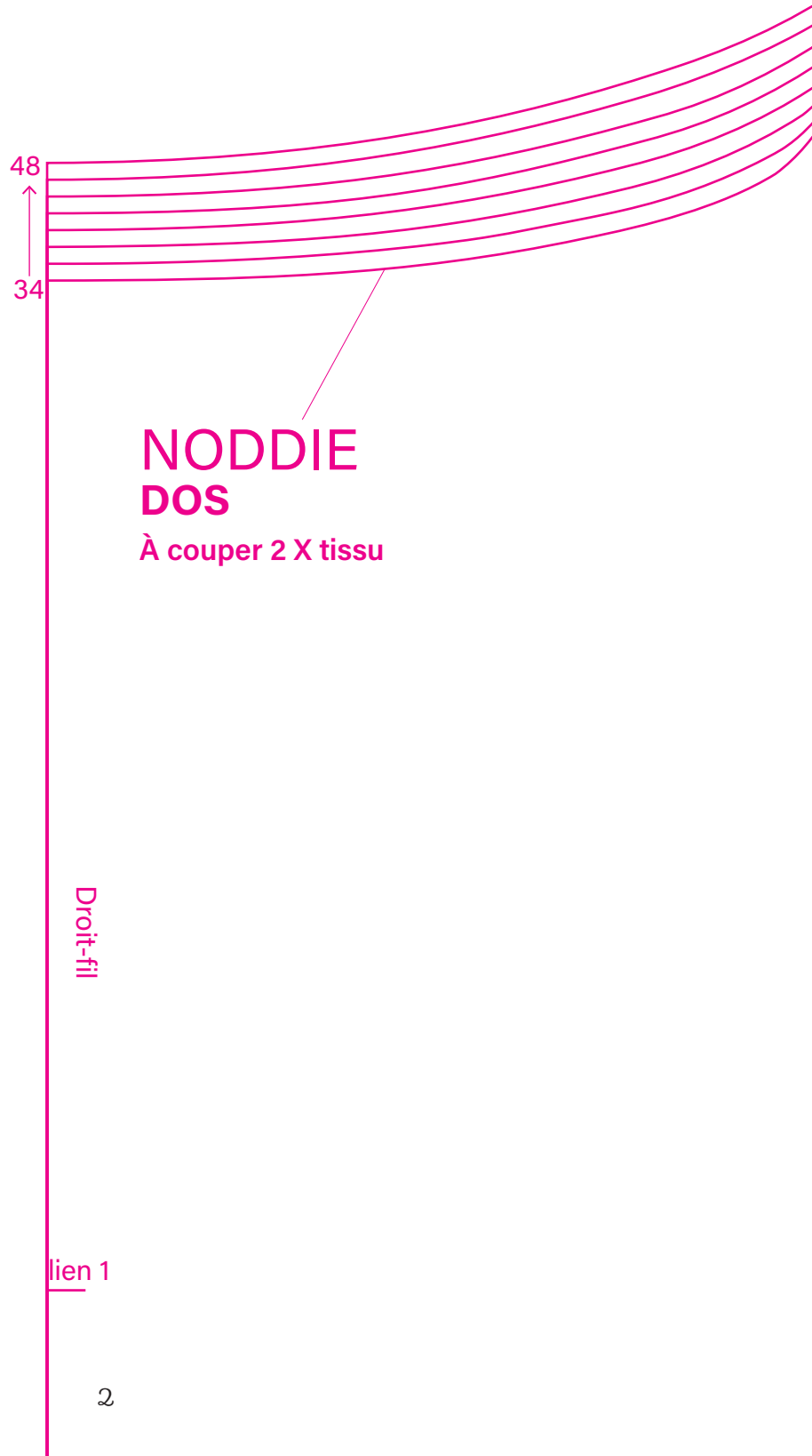
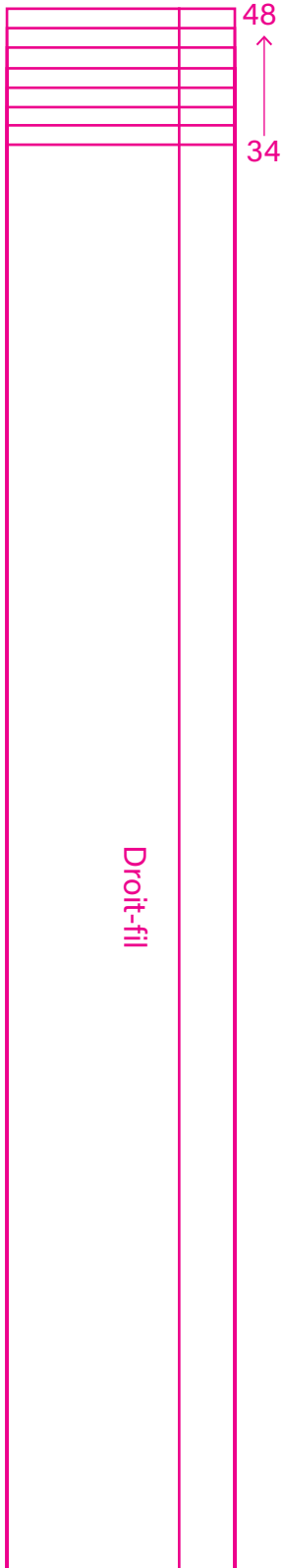

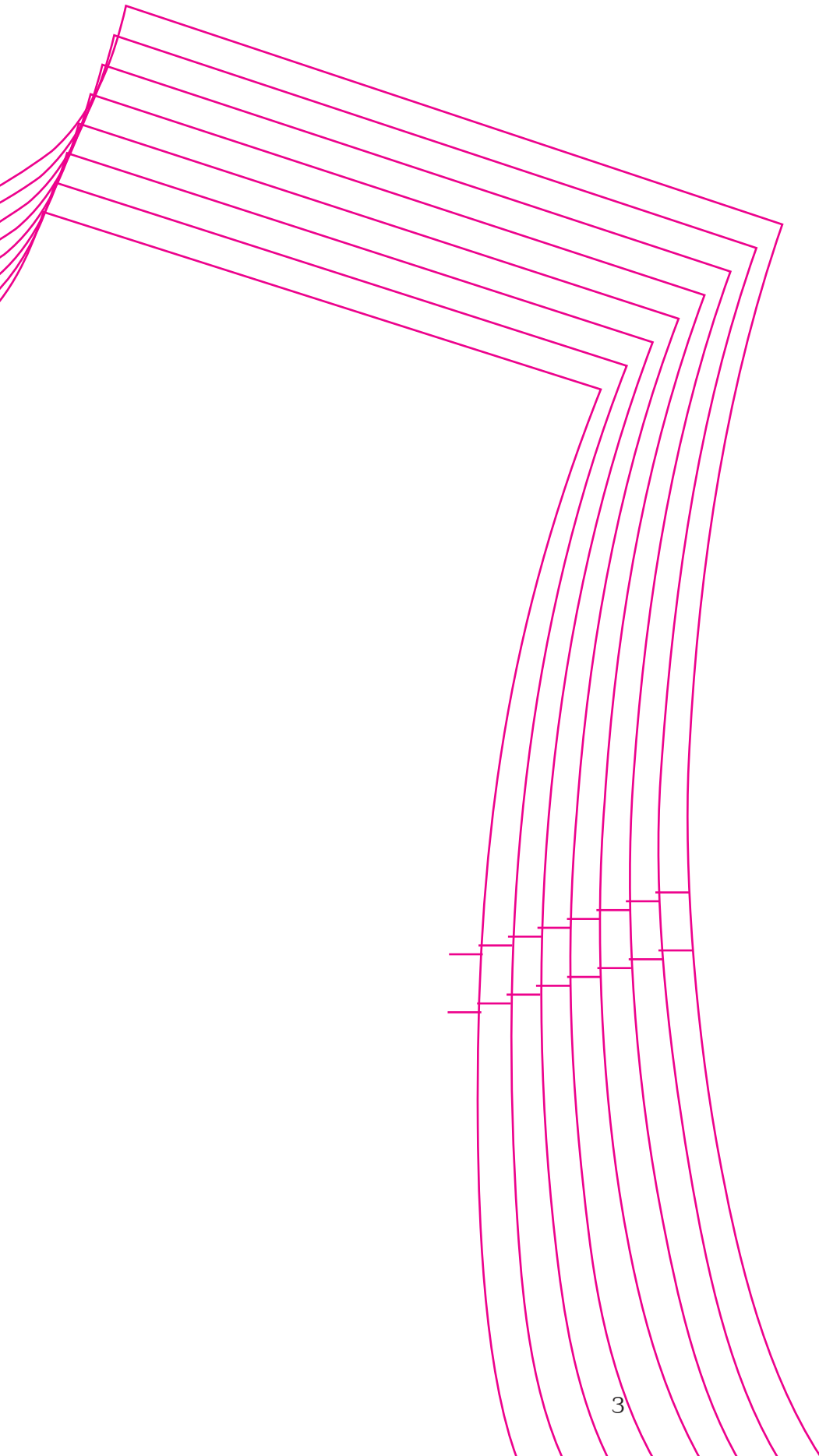

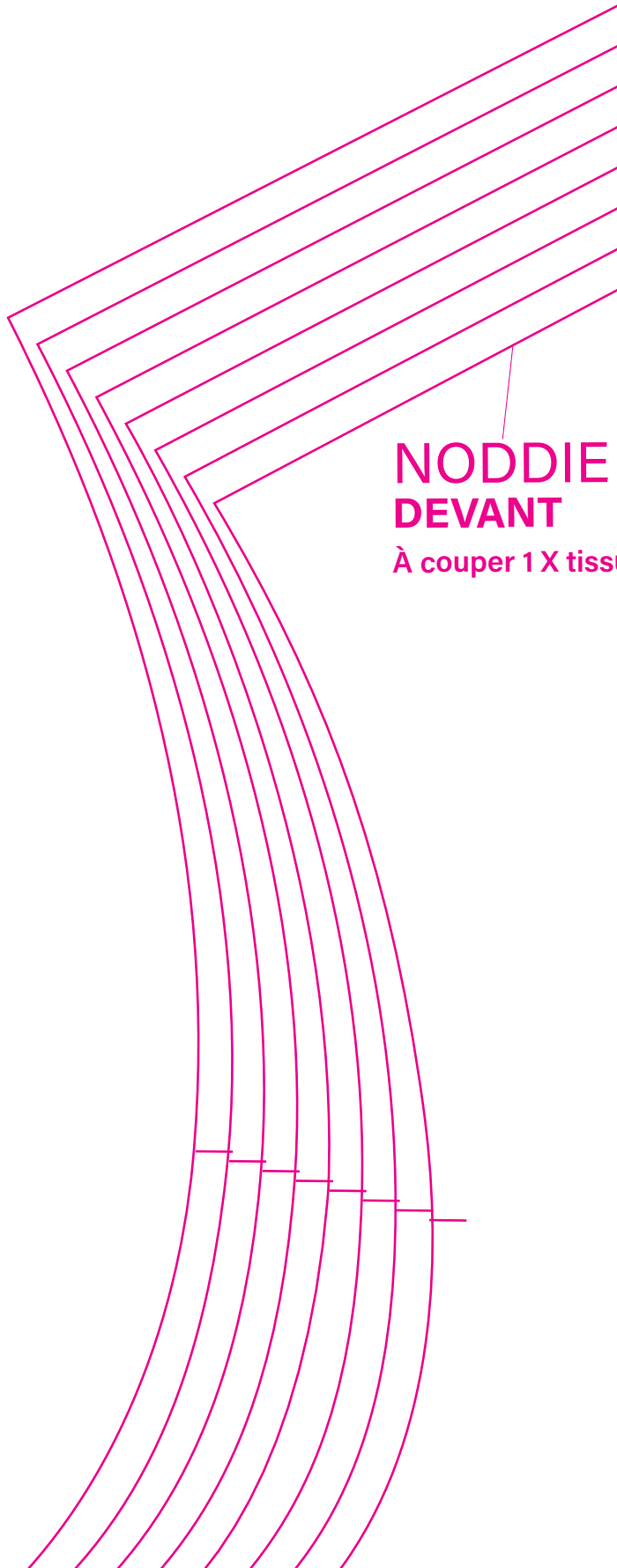

**NODDIE
DEVANT**

À couper 1 X tissu

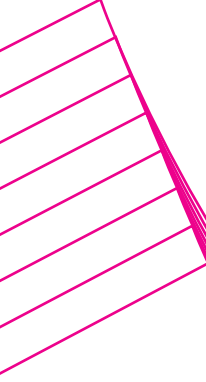

u au pli

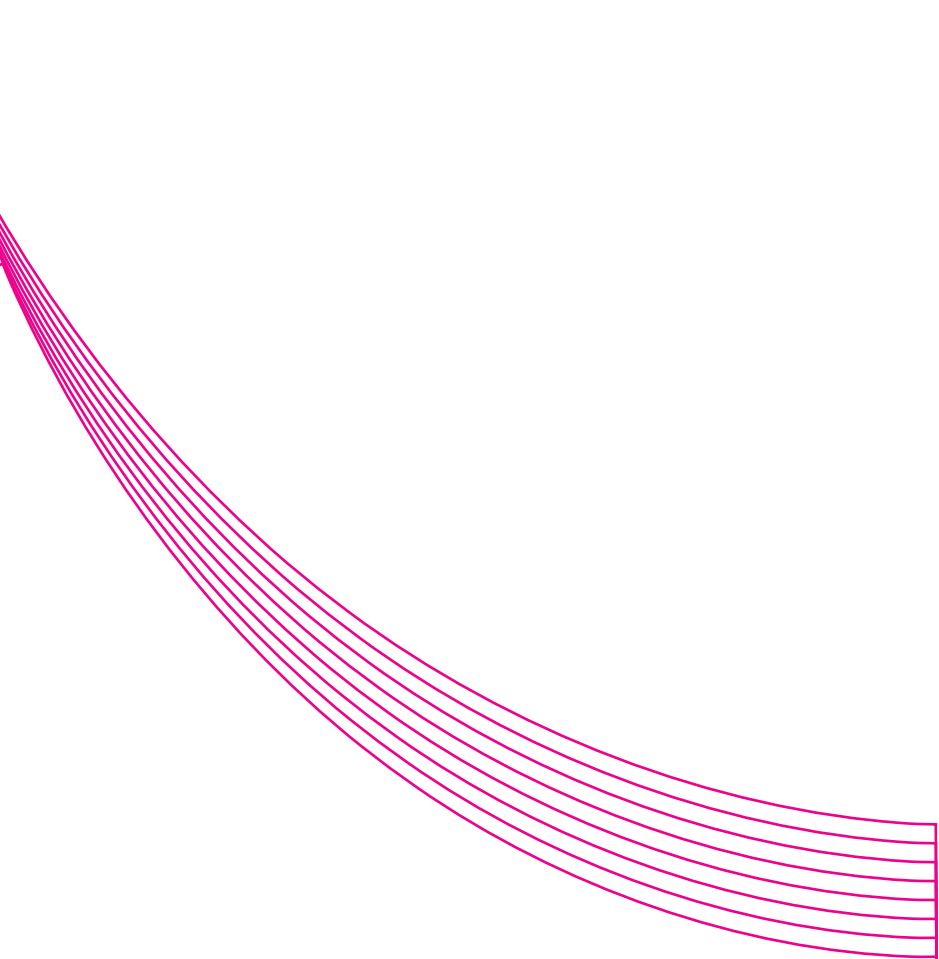

48
↑
34

au pli



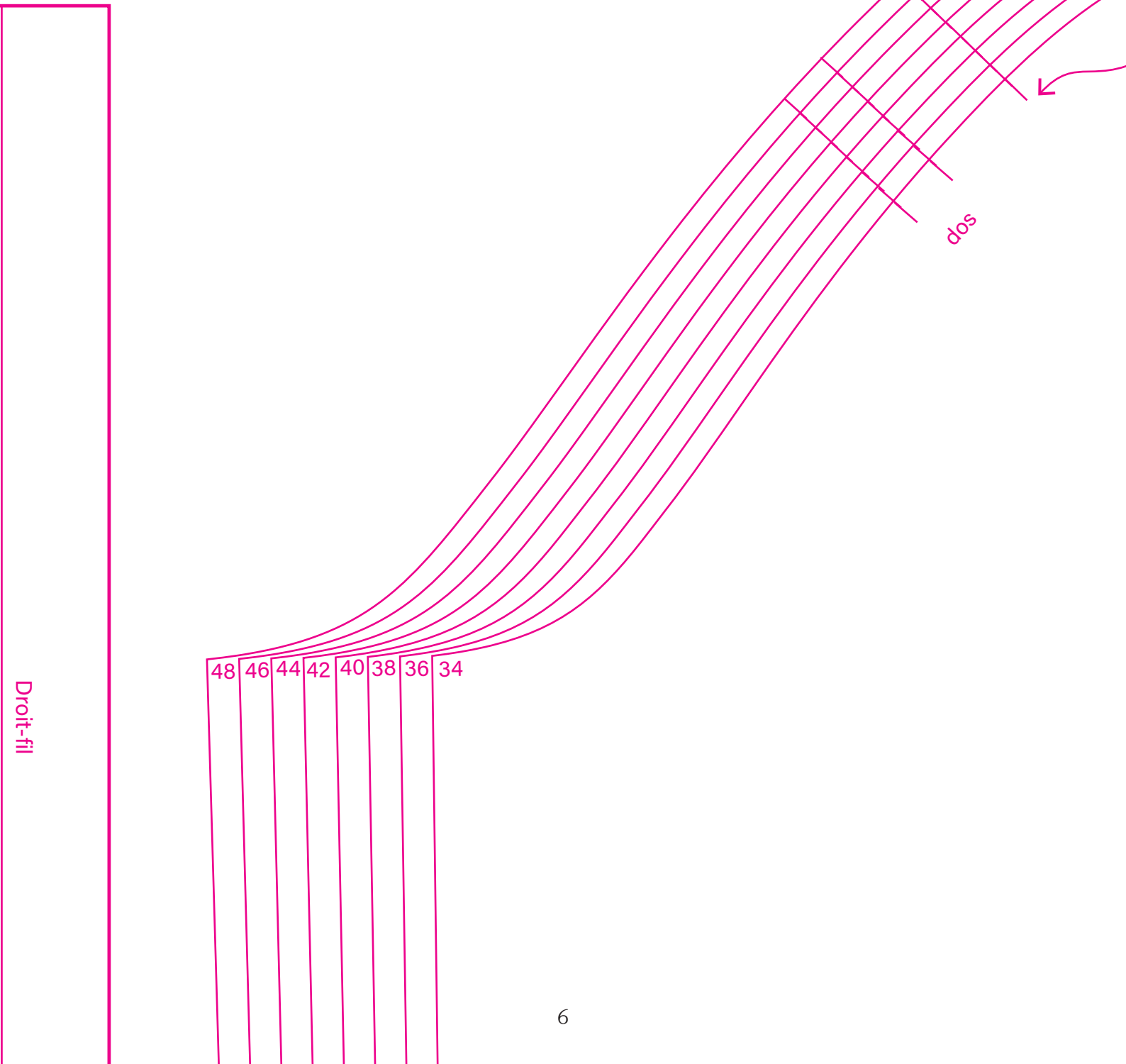

MODDIE - MANCHE

couper 2 X tissu

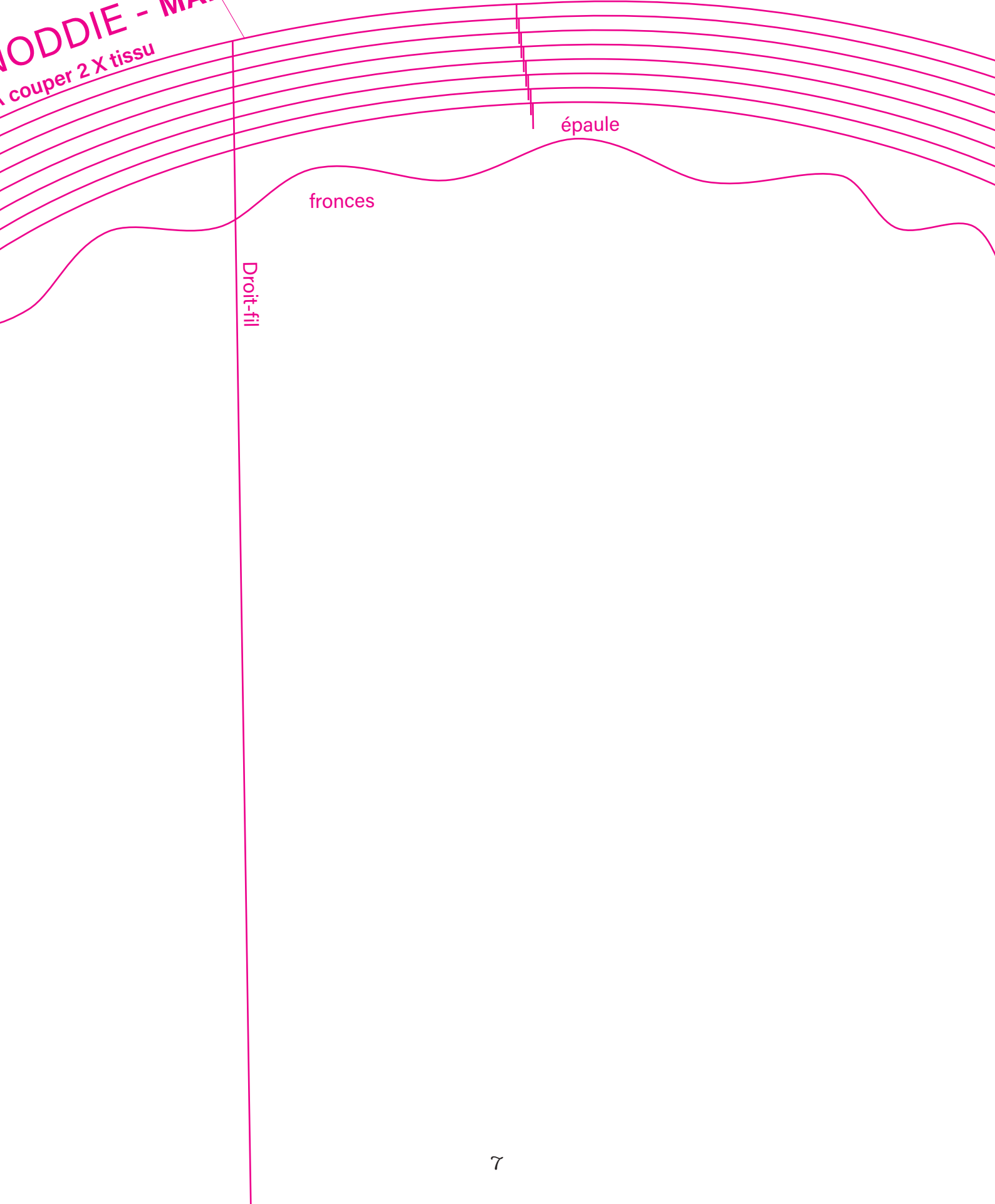

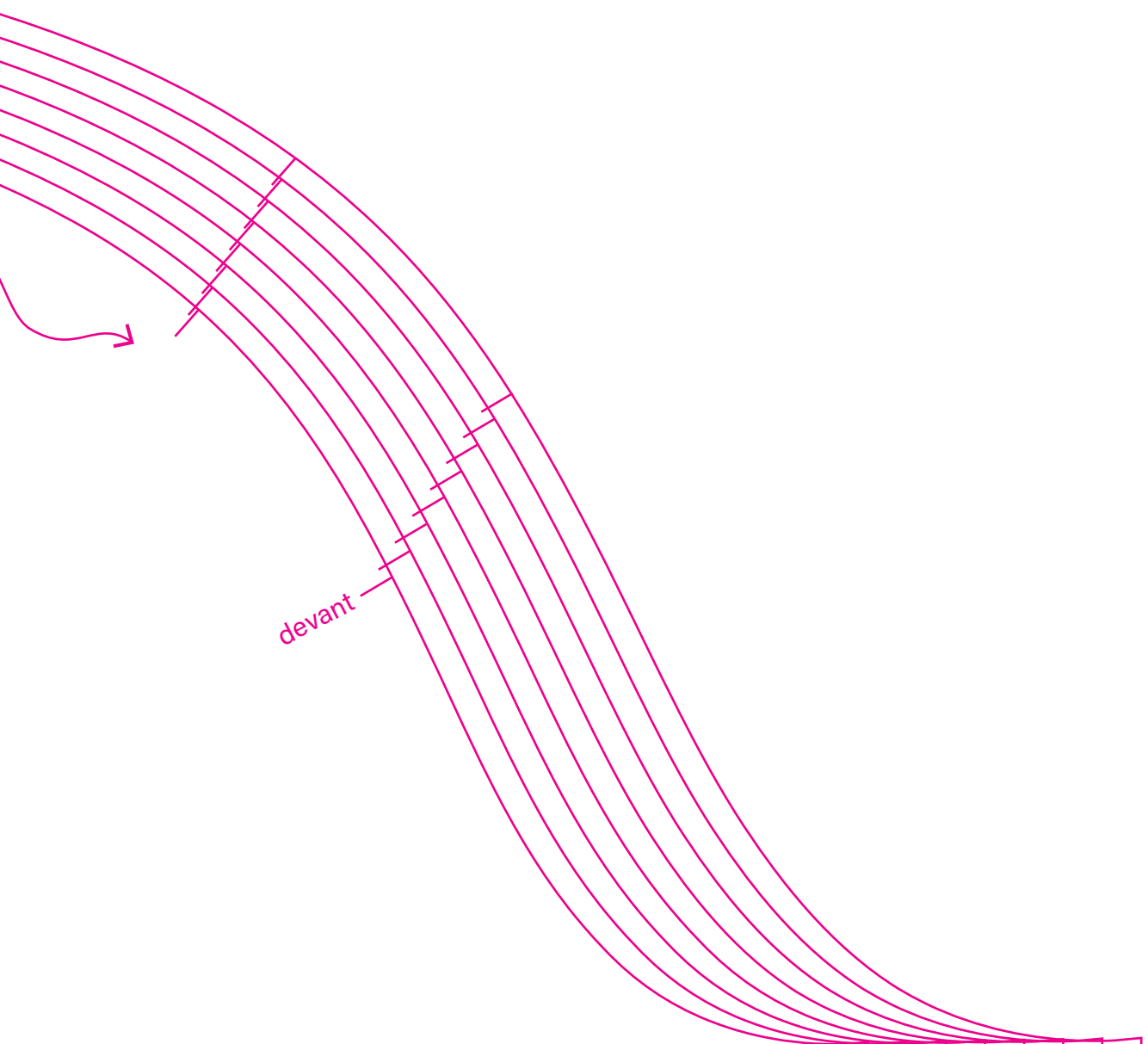

34 36 38 40 42 44 46 48

NODDIE

VERSION MANCHES LONGUES BRACELET DE MANCHE

À couper 2 X tissu

et 2 X thermocollant sur la moitié

ligne de pliure

Droit-fil

34	38	42	46	48
36	40	44		

NODDIE - VERSION MILIEU DOS AVEC LIENS
BORDURE MILIEU DOS

À couper 2 X tissu et 2 x thermocollant



longueur ROBE

lien 2

longueur robe

34

36

38

40

42

44

46

48

48 46 44 42 40 38 36 34

À c
en
(
à r

LIENS (pour la ceinture)

À couper 2 X tissu

LIENS A NOUEN

À couper 2 X tissu

longueur robe

Droit-fil

couper
n 2 ici
liens
(nouer)

LIENS (pour la structure)
VERSION ROBE

NODDIE

LIENS À NOUER
VERSION MILIEU DOS AVEC LIENS

NODDIE

version manches 3/4

NODDIE

VERSION ROBE À BASQUES

PANS DU HAUT, DOS et DEVA

À couper 2 X tissu au pli

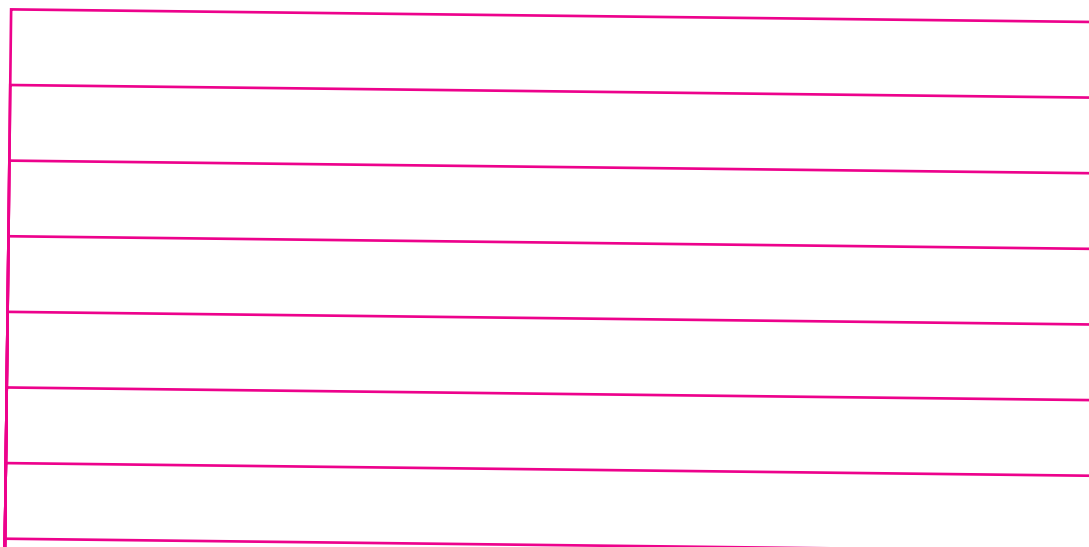

longueur
BLOUSE

longueur blouse

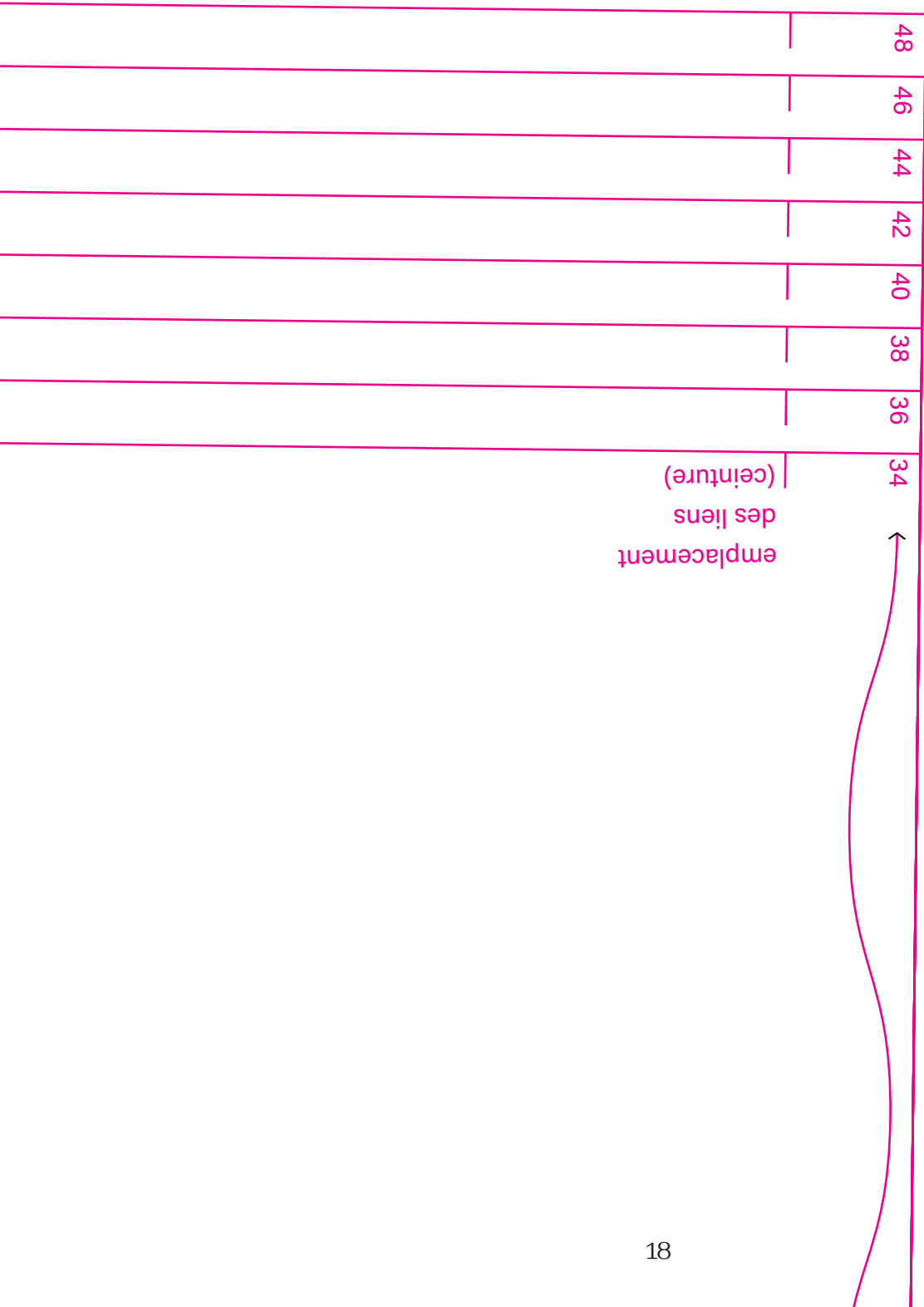

--	--	--	--	--	--	--	--

48 ← 34

--	--	--	--	--	--	--	--

Droit-fil

48 46 44 42 40 38 36 34 ←

E
 LIEU DOS AVEC BOUTONS
E BOUTONNAGE DOS
 tissu
 collant



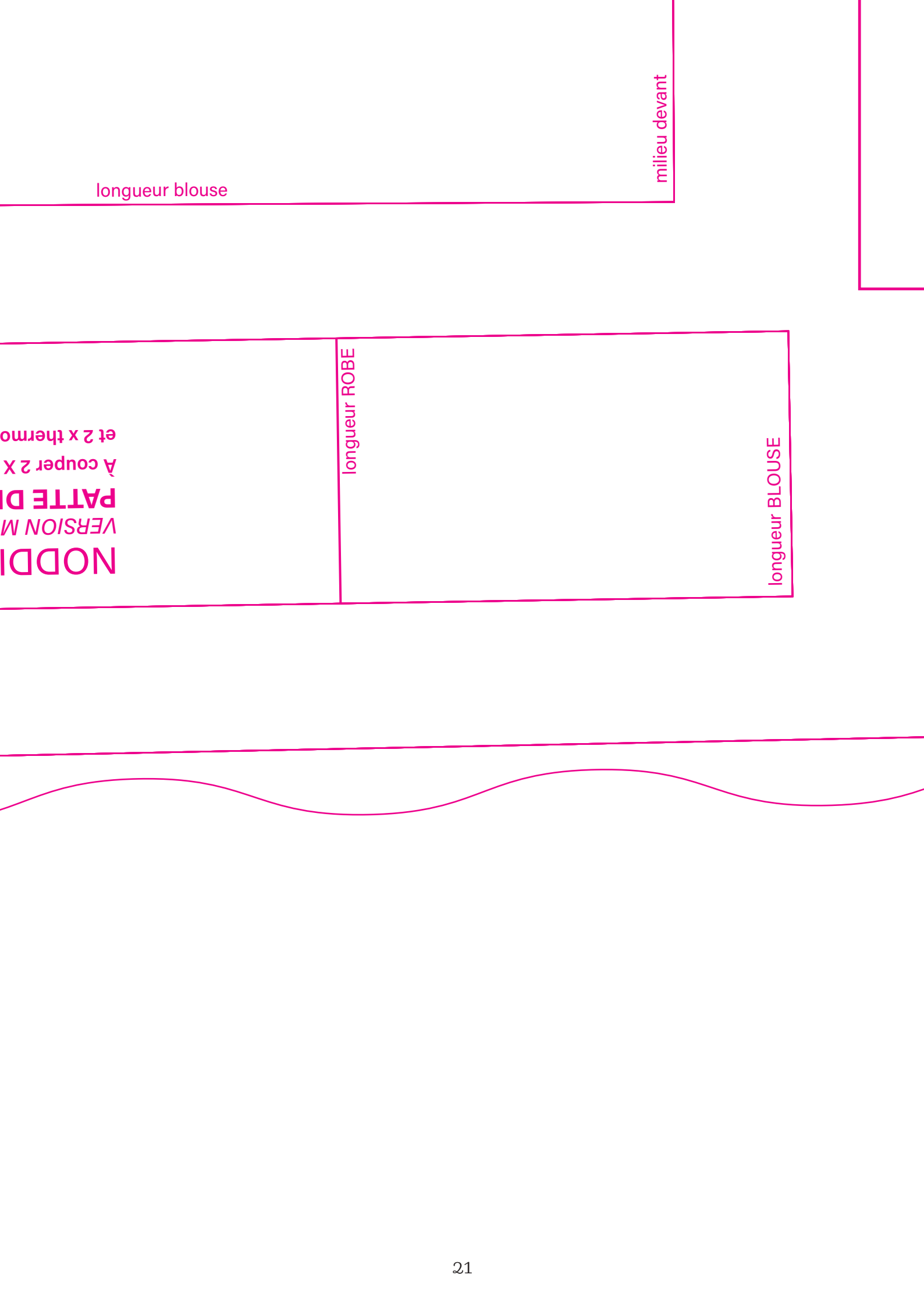

longueur blouse

milieu devant

NODDI
VERSION M
PATTE D
À couper 2 X
et 2 x thermo

longueur ROBE

longueur BLOUSE

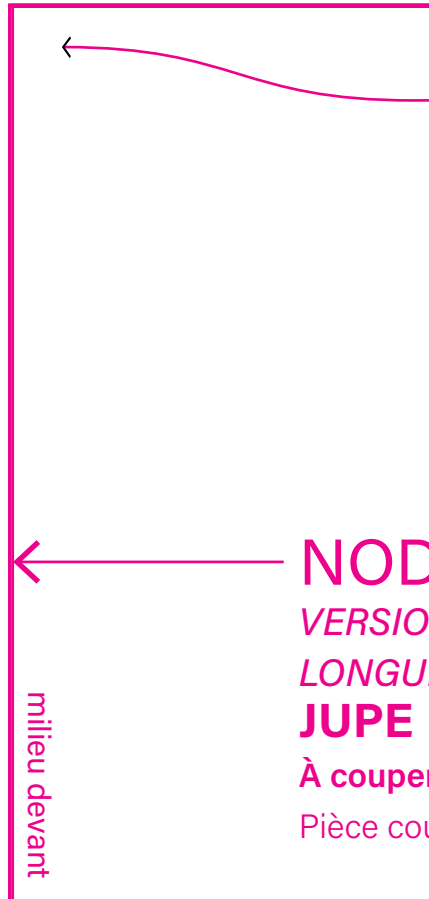
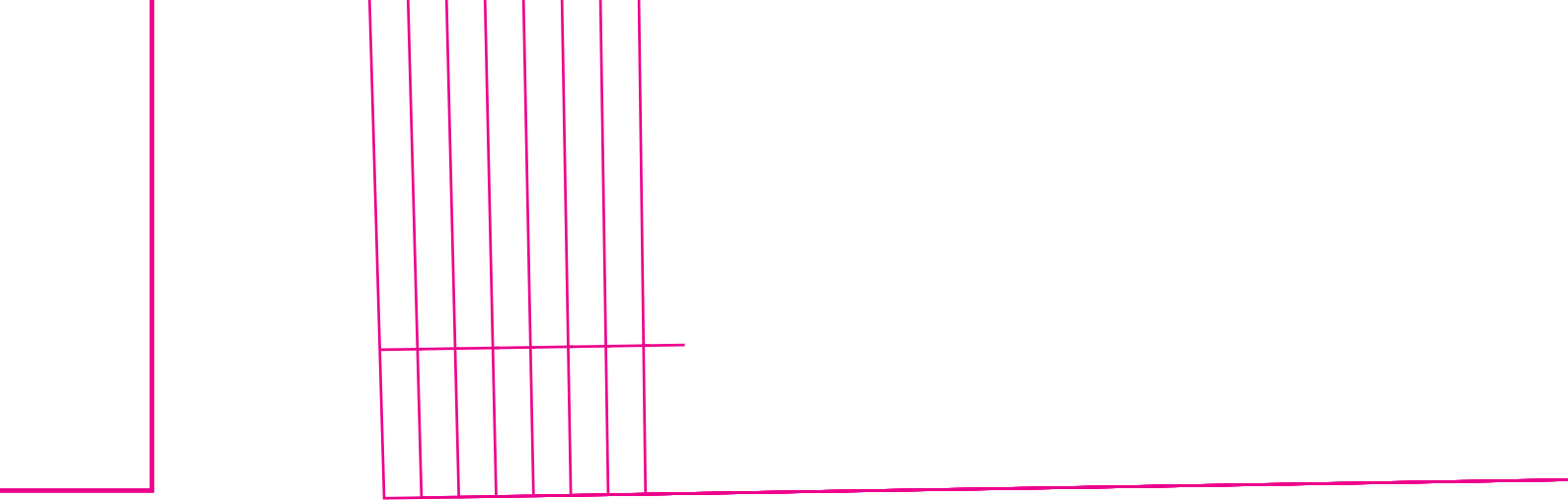

version manches longues

Droit-fil

fronces

milieu dos

Droit-fil

MODIE
DEVANT

pour 1 X tissu au pli

plissée en 2 (partie 1/2)

34
36
38
40
42
44
46
48

	34	36	38	40	42	44	46	48
→ emplacement des liens (ceinture)	—	—	—	—	—	—	—	—
→								

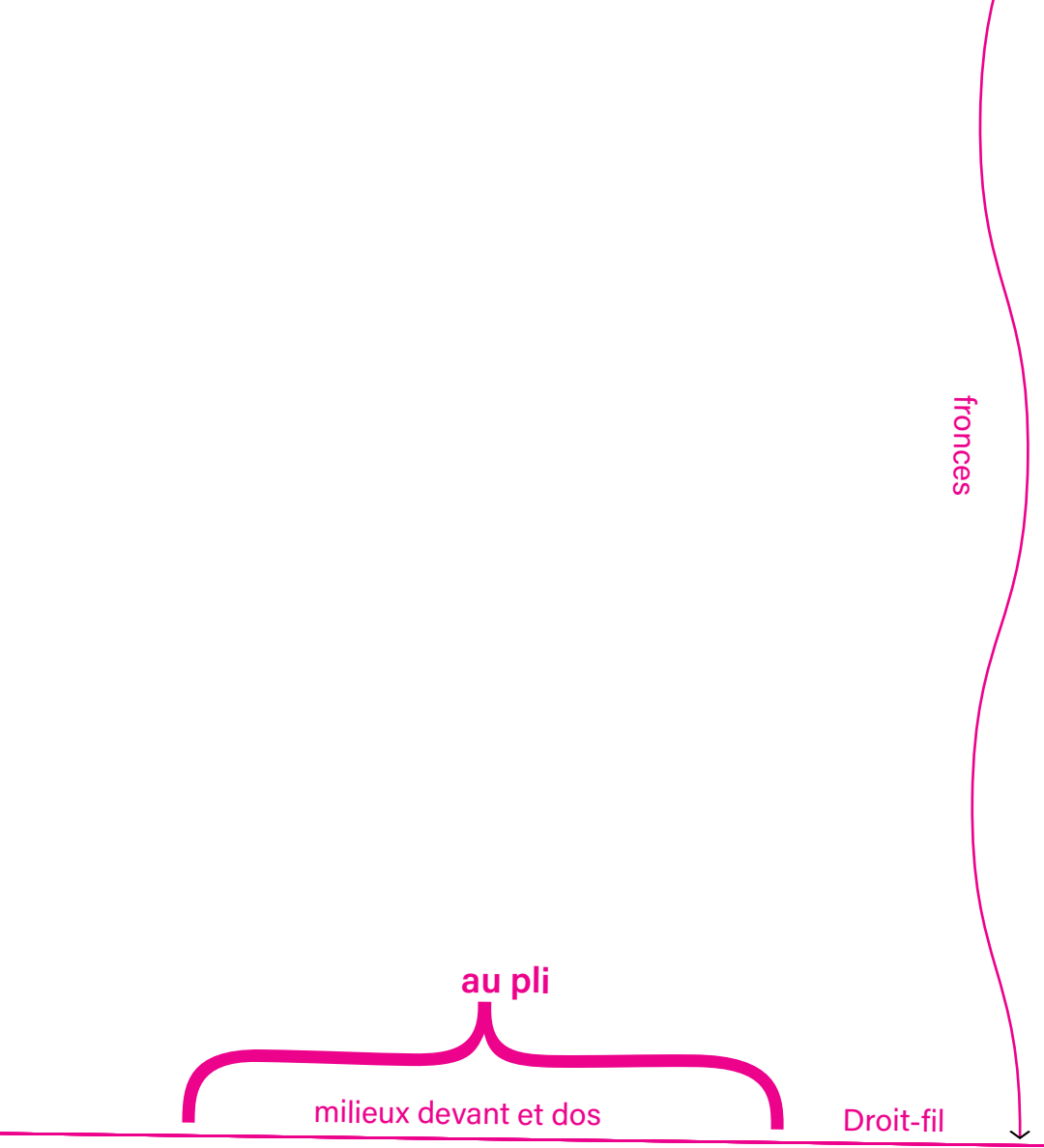

NODDIE
 VERSION ROBE LONGUE
JUPE DOS
 À couper 1 X tissu au pli
 Pièce coupée en 2 (partie 2/2)

e coupée en 2 (partie 2/2)

À couper 1 X tissu au pli

PE DEVANT

IGUE

SSION ROBE

NODDIE

NON
VERH
LON
JUN
À co
Pièc

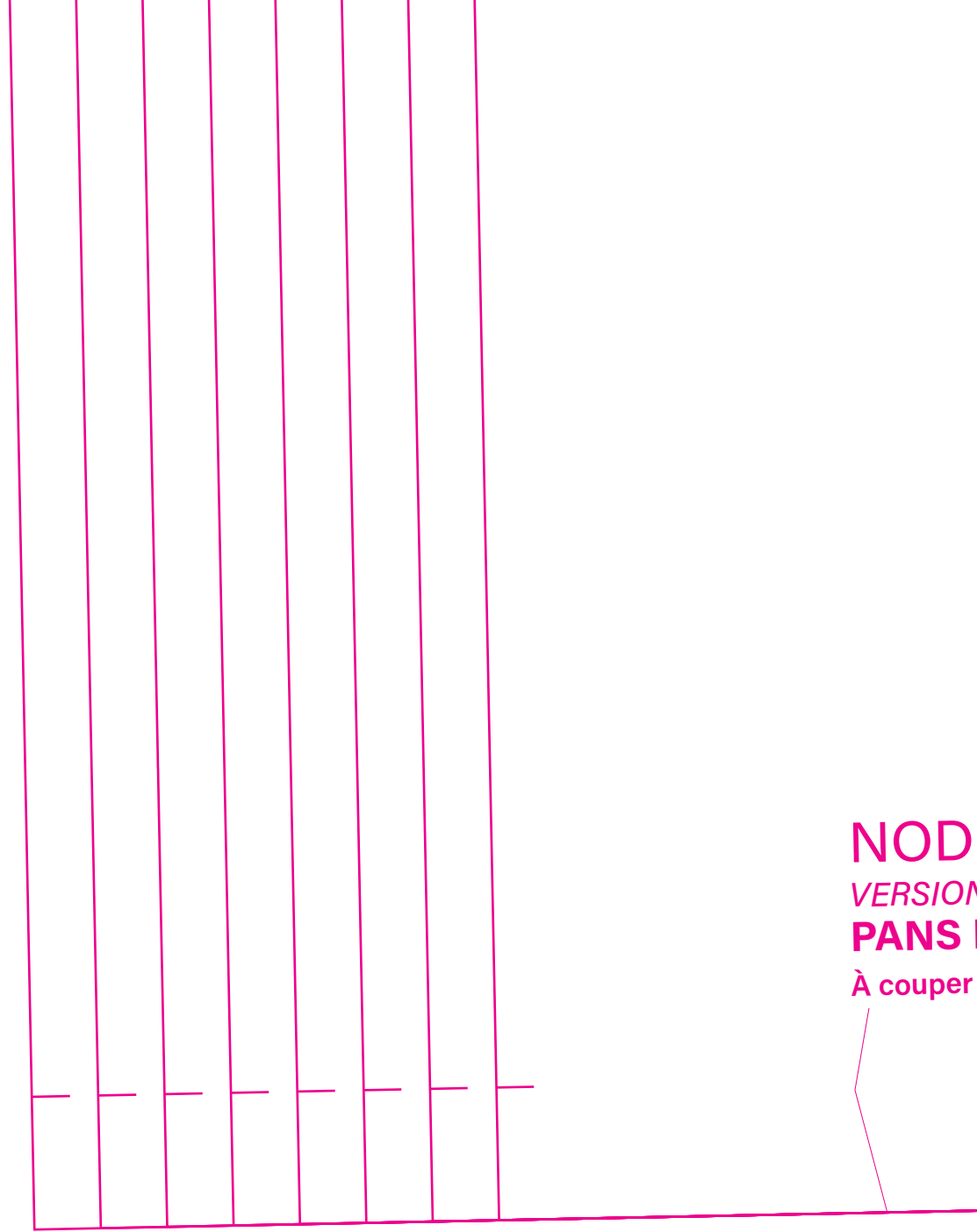

NOD
VERSION
PANS
À couper

DIE
UN ROBE À BASQUES
DU BAS, DOS et DEVANT
2 X tissu au pli

au pli

milieux devant et dos

Droit-fil

ligne de raccord



NODDIE

VERSION ROBE LONGUE

JUPE DOS

À couper 1 X tissu au pli

Pièce coupée en 2 (partie 1/2)

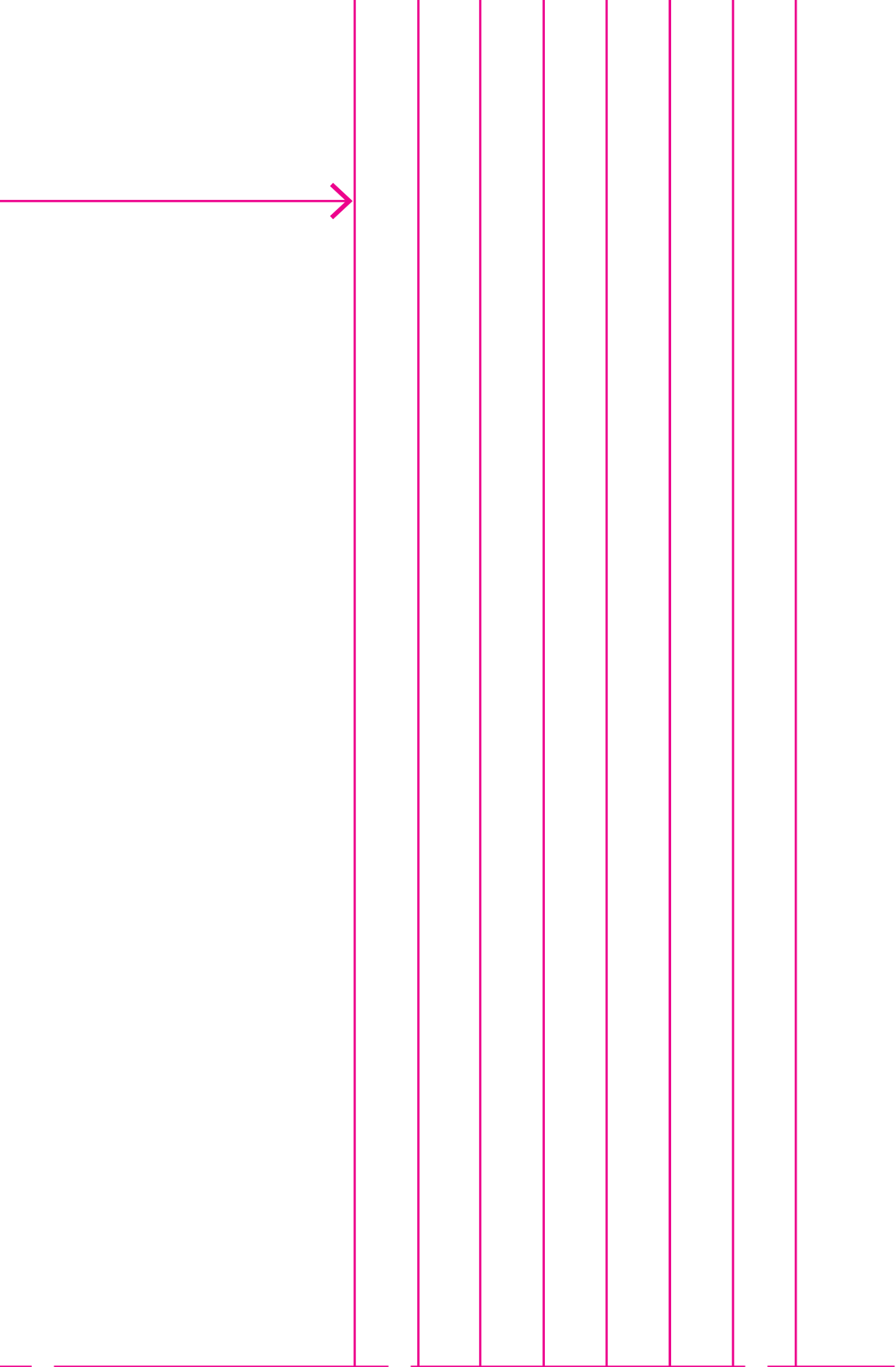

repère
fente

ligne de raccord

au pli



au pli



Mon joli dressing

Célia Moreau
@little_c_celia



Patron à reconstituer

Nos patrons sont à imprimer sur du papier format A4.
Les pages sont numérotées. Les assembler bord à bord
avec du ruban adhésif. Il y a lieu de prolonger les lignes
d'une page sur l'autre avant de couper les patrons.

Schéma de montage

1	2	3	4	5	6	7	8
9	10	11	12	13	14	15	16
17	18	19	20	21	22	23	24
25	26	27	28	29	30	31	32
33	34	35	36				
37	38	39	40				

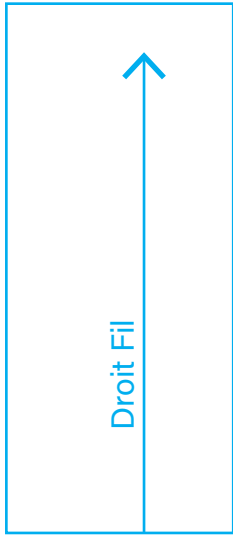

HEARTIE PASSANT

À couper 4 X tissu
et 4 X thermocollant

À couper 1 X tissu
**HEARTIE
DEVANT GAUCHE
(dessus)**

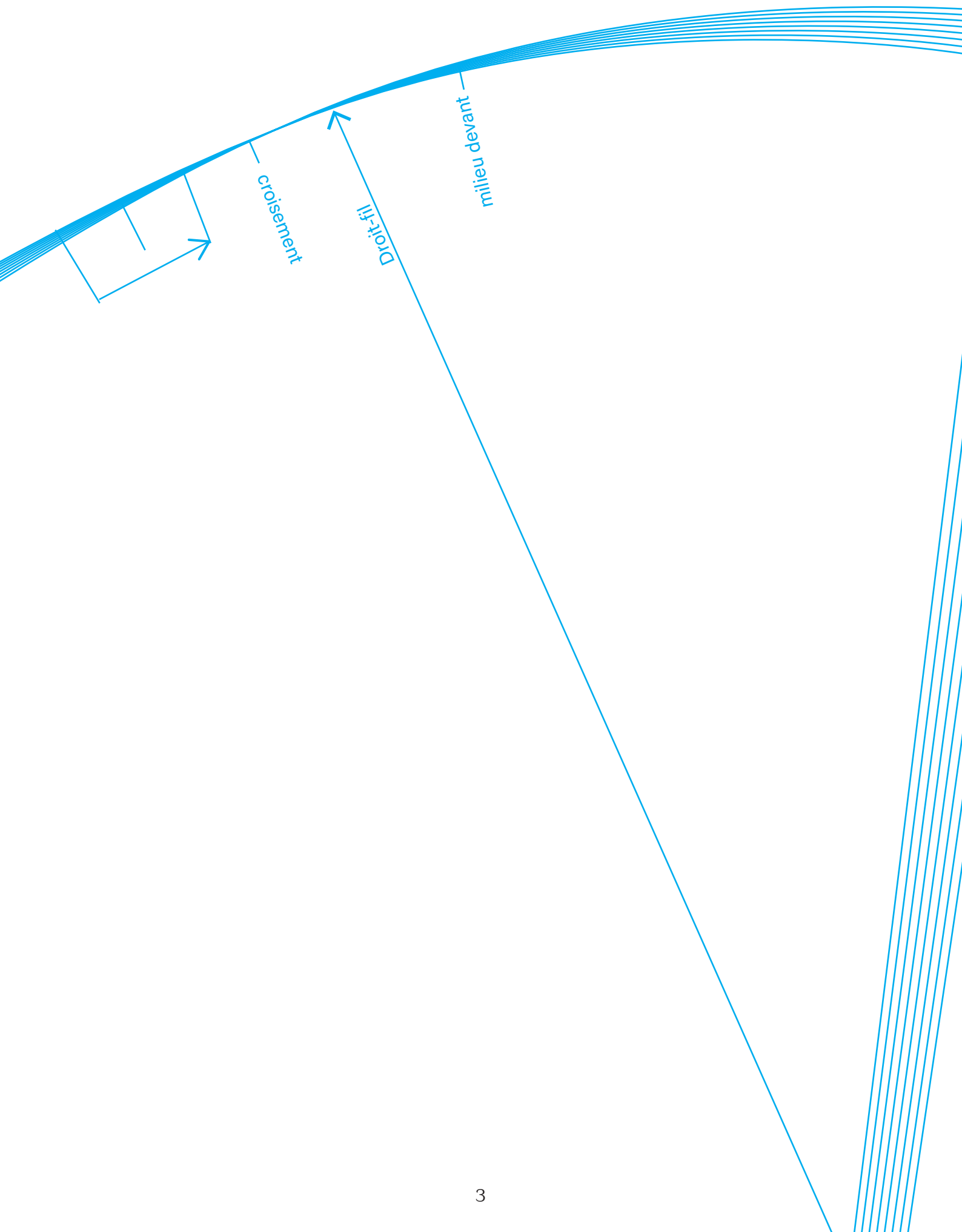

HEARTIE BIAIS D'ENCOLURE

À couper 2 X tissu

34	36	38	40	42	44	46	48
----	----	----	----	----	----	----	----

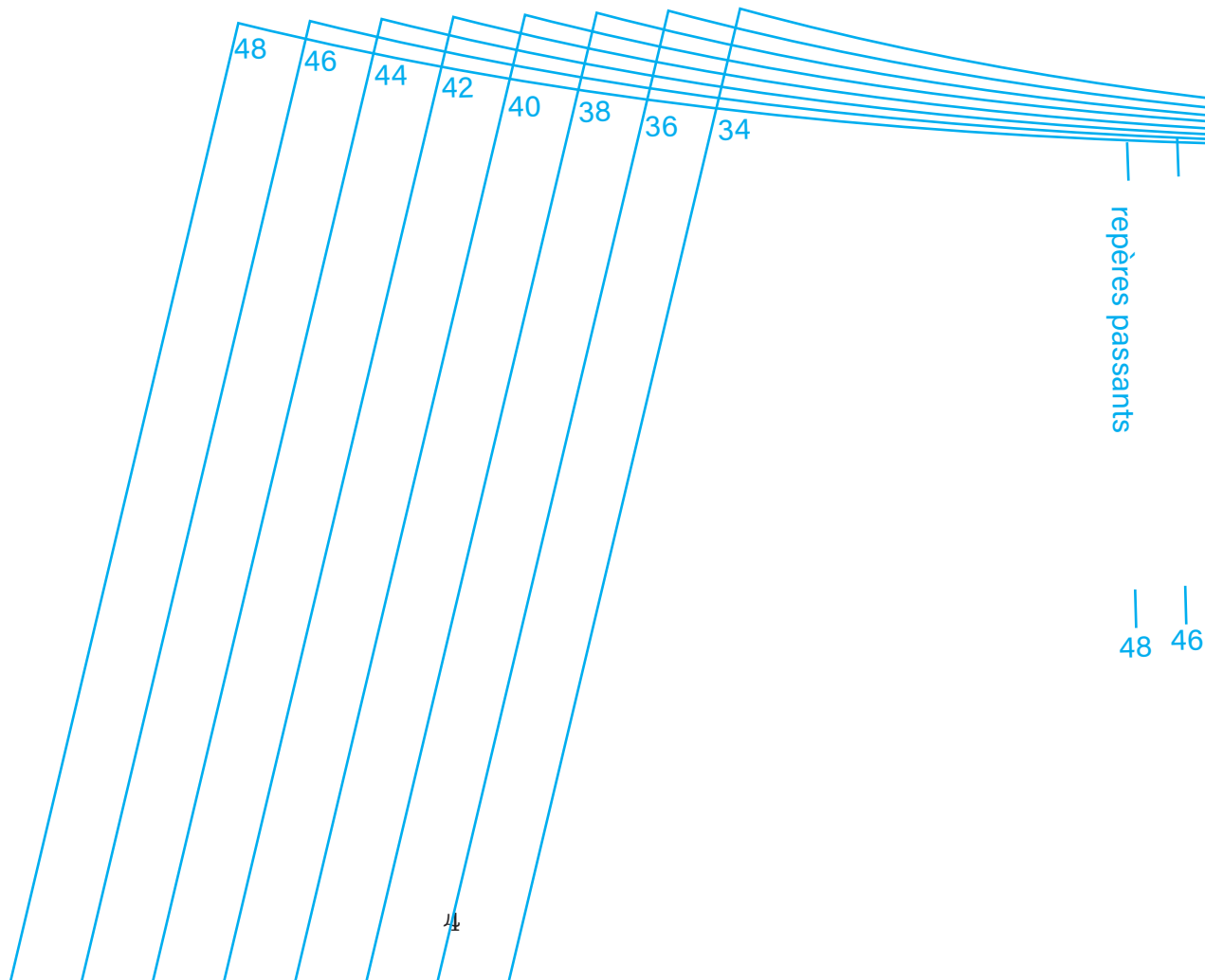

repères passants

48 46

HEARTIE JUPE DEVANT

À couper 1 X tissu au pli

Droit-fil

44 42 40 38 36 34

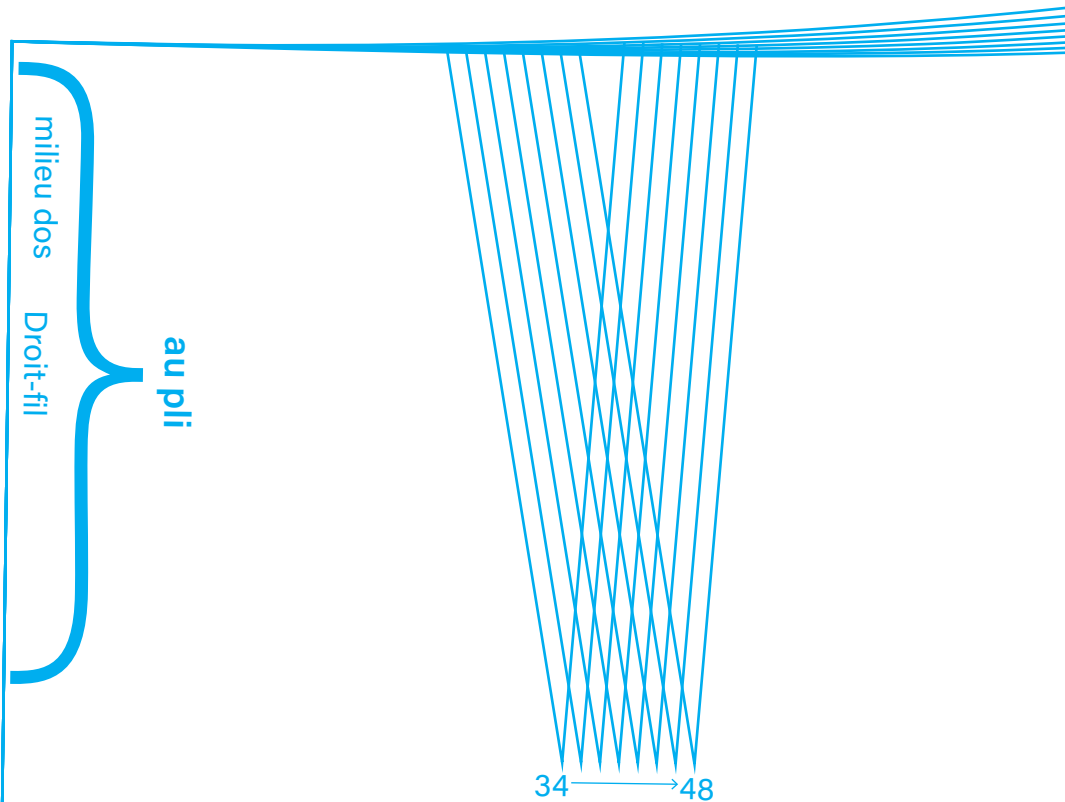
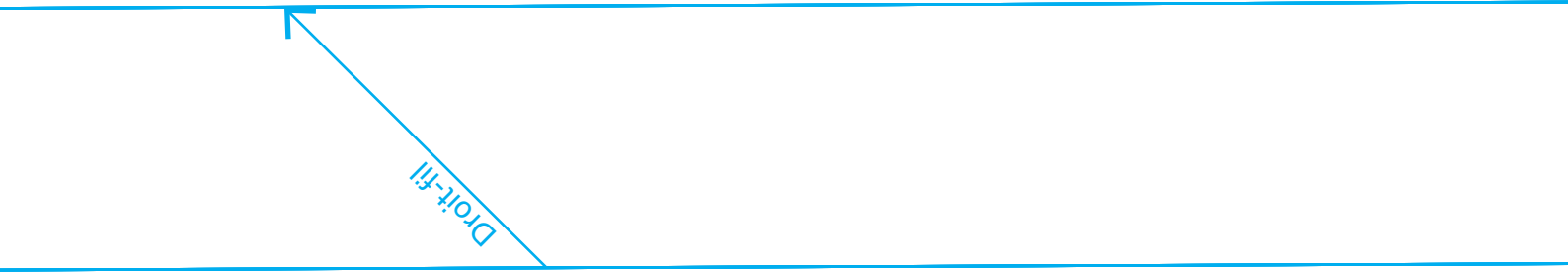

ligne
d'assemblage
des
deux bords

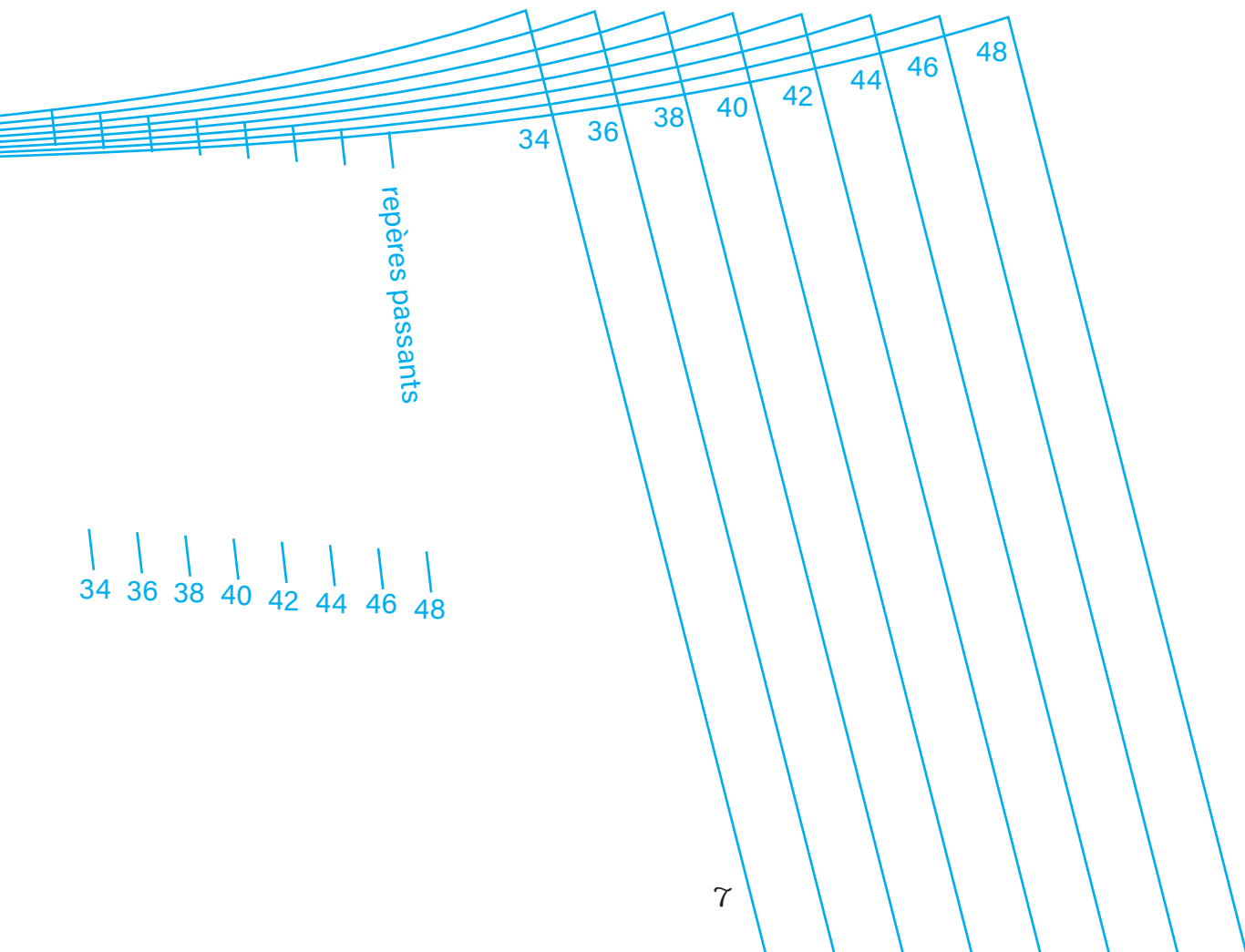



Droit-fil

HEARTIE CEINTURE

(convient pour une boucle de ceinture de 5 cm de diamètre)

À couper 2 X tissu et 1 X thermocollant

Pièce coupée en 2 (partie 1/2)

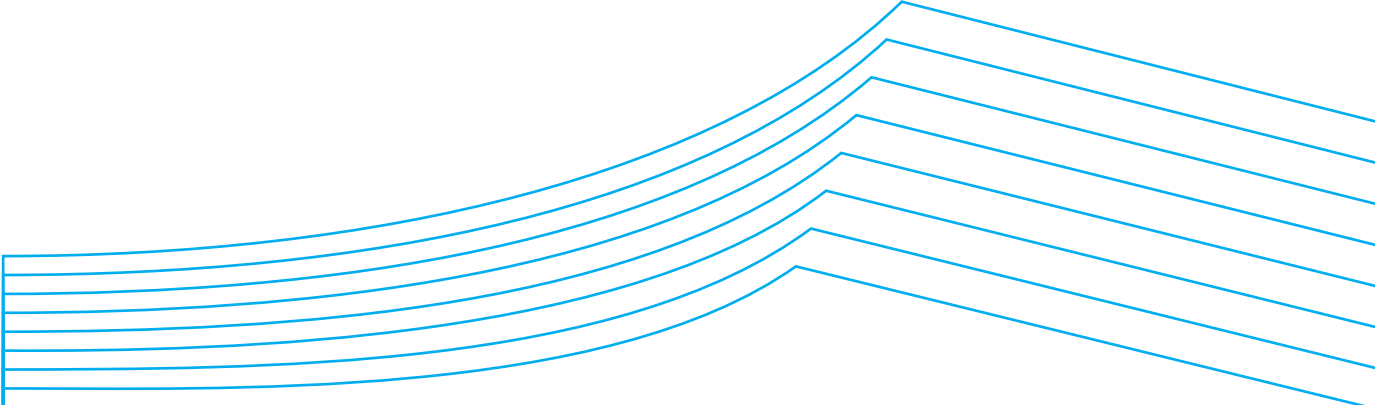

Droit-fil

milieu dos



au pli

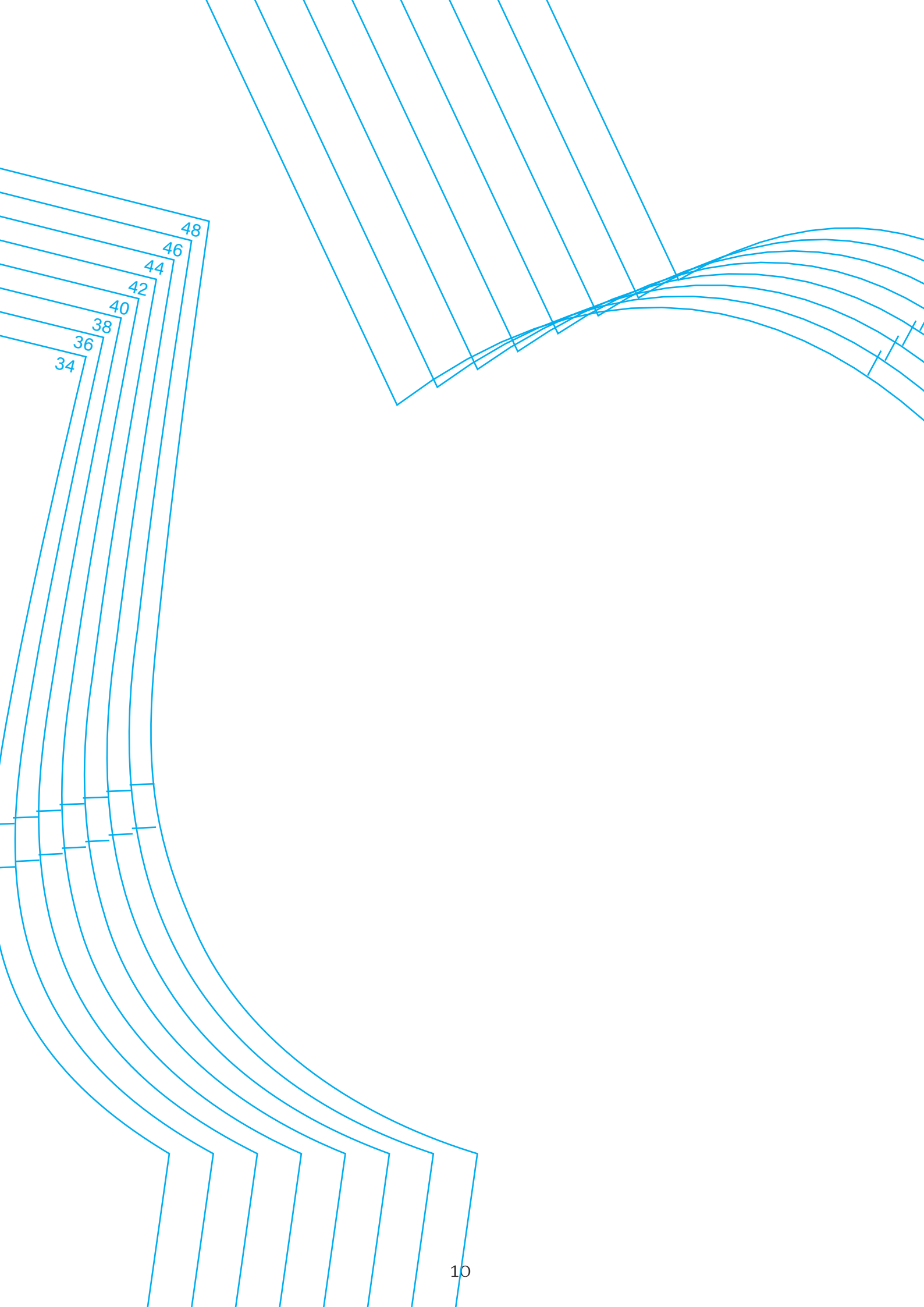

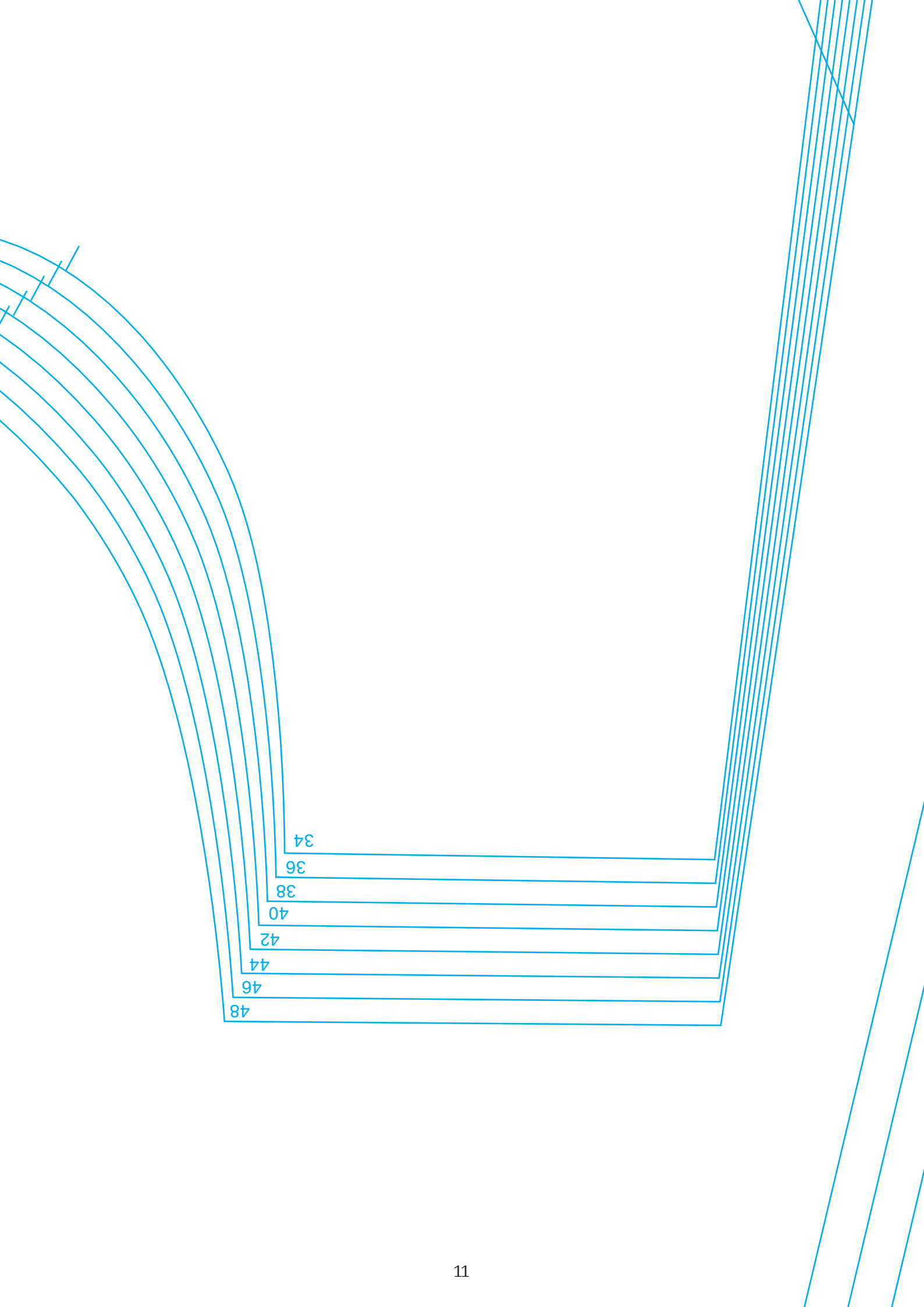

34
36
38
40
42
44
46
48

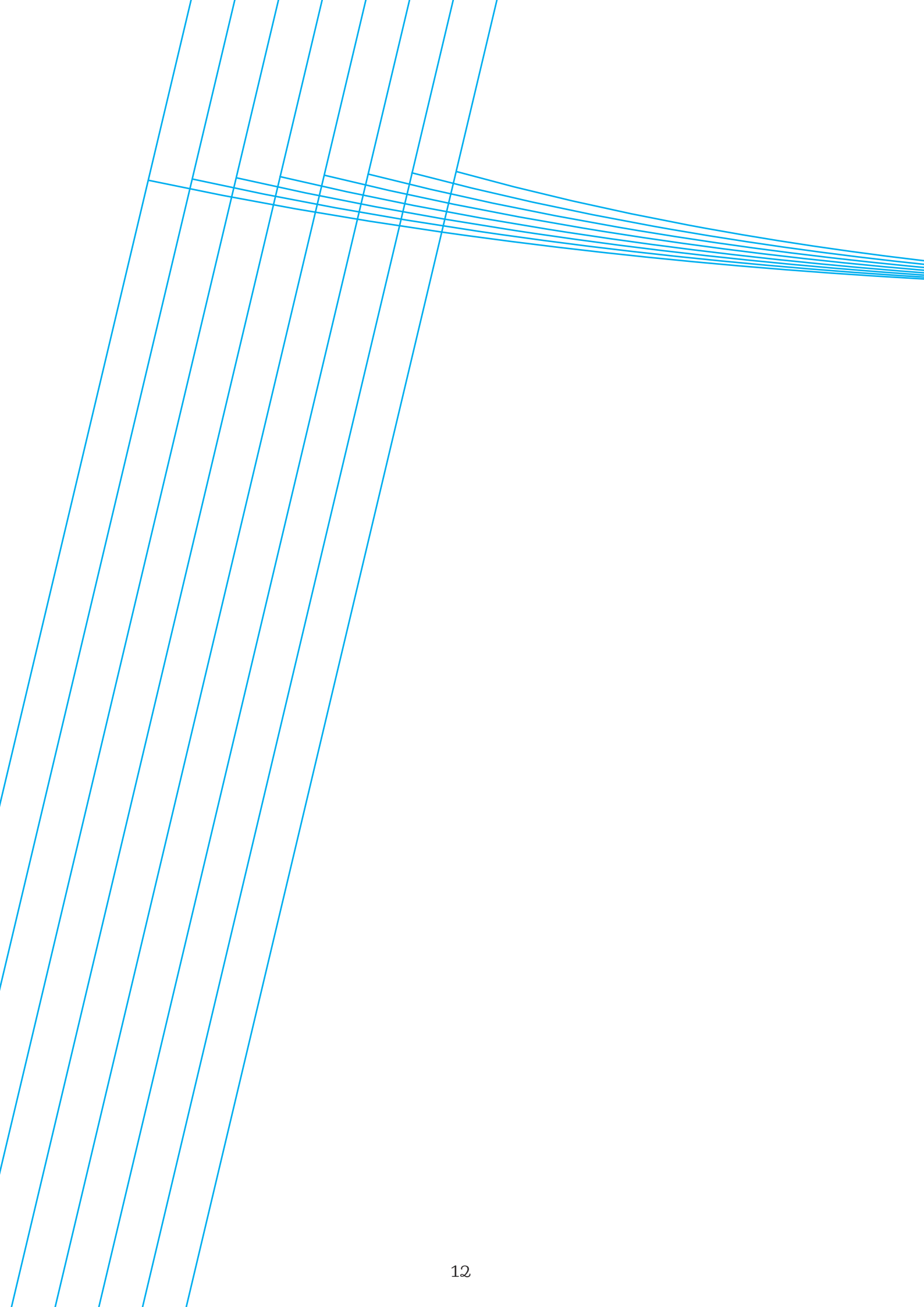

longueur blouse

au pli



longueur blouse

HEARTIE JUPE DOS

À couper 1 X tissu au pli

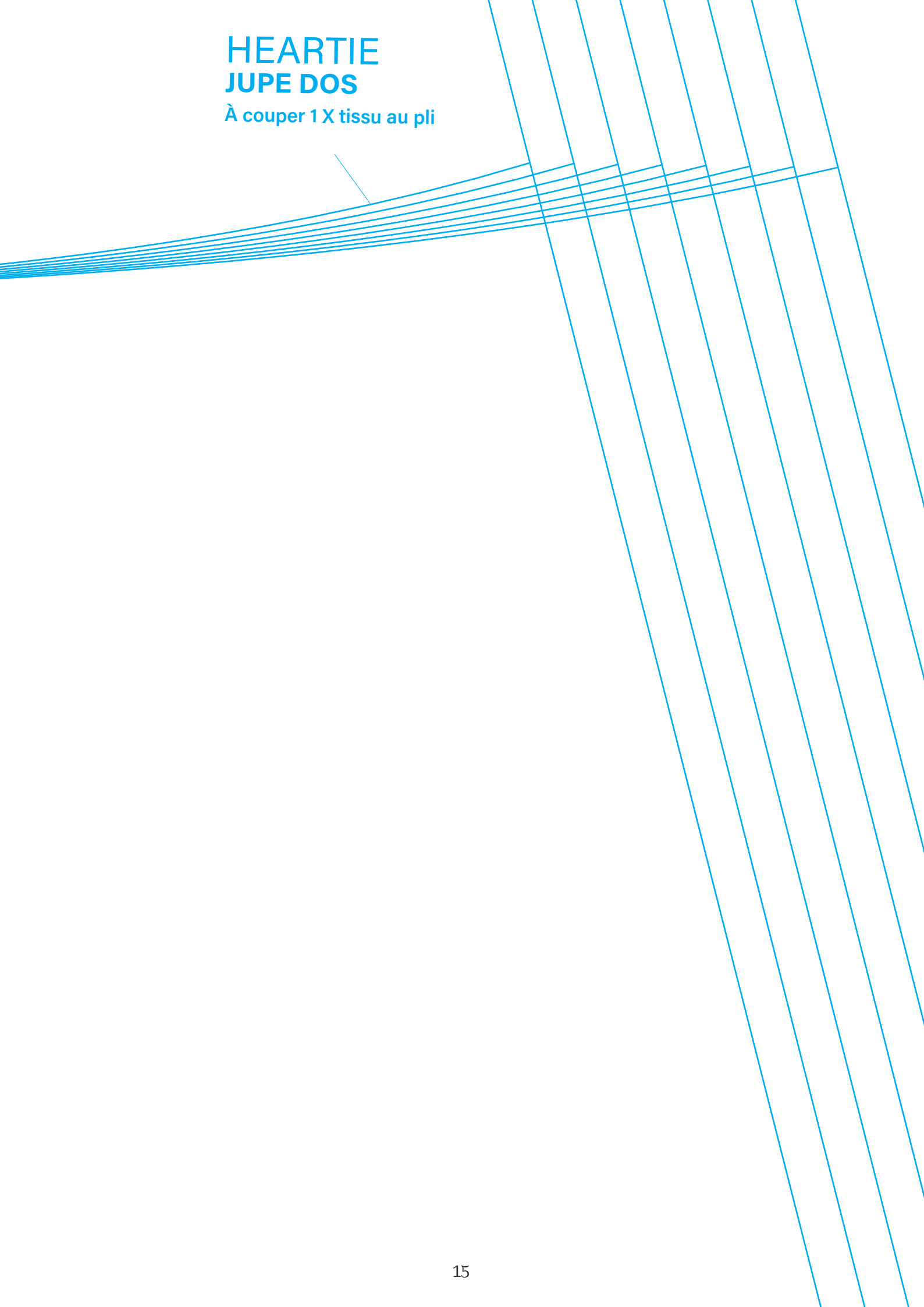



repère
pour
l'ouverture



HEARTIE DOS

À couper 1 X tissu au pli

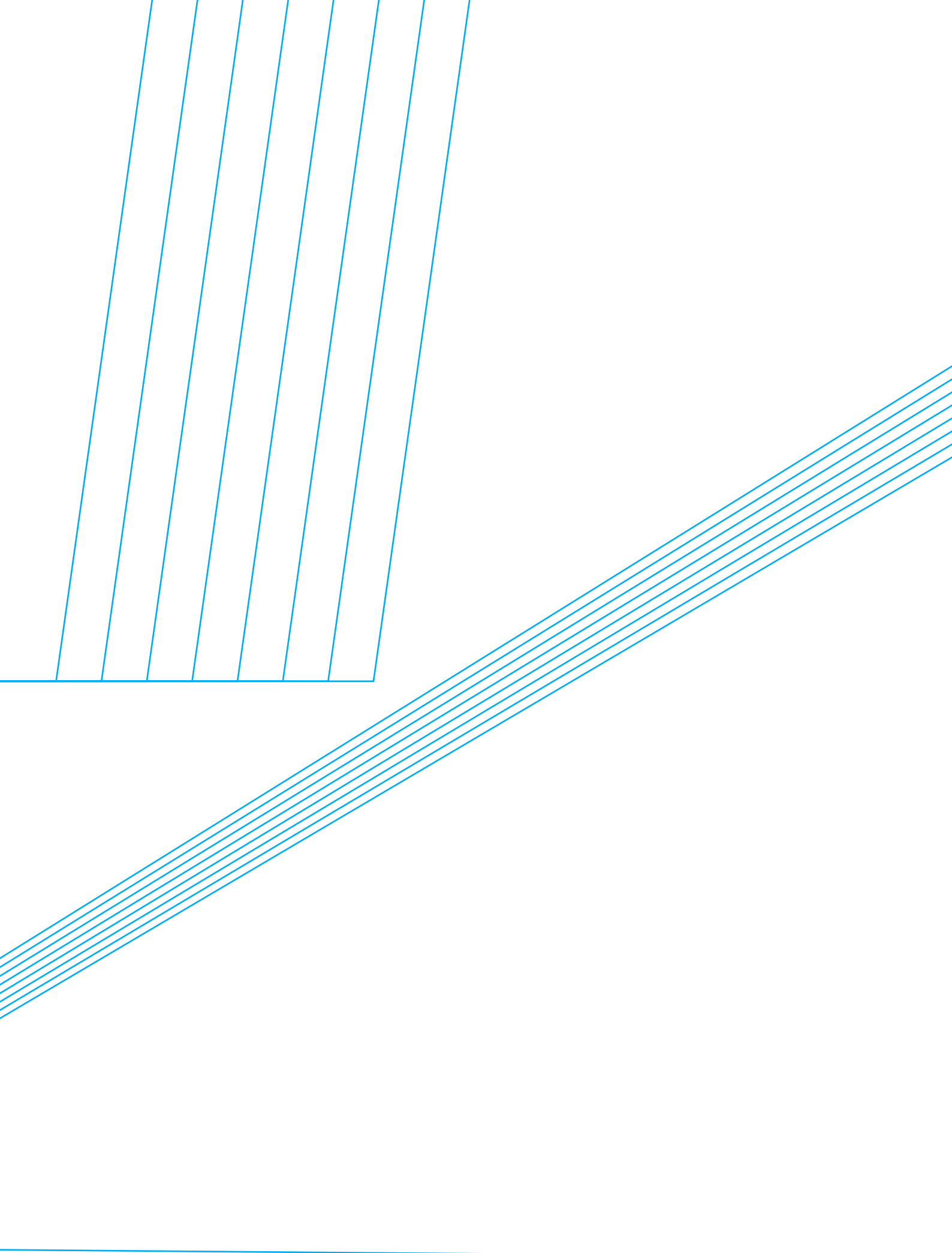

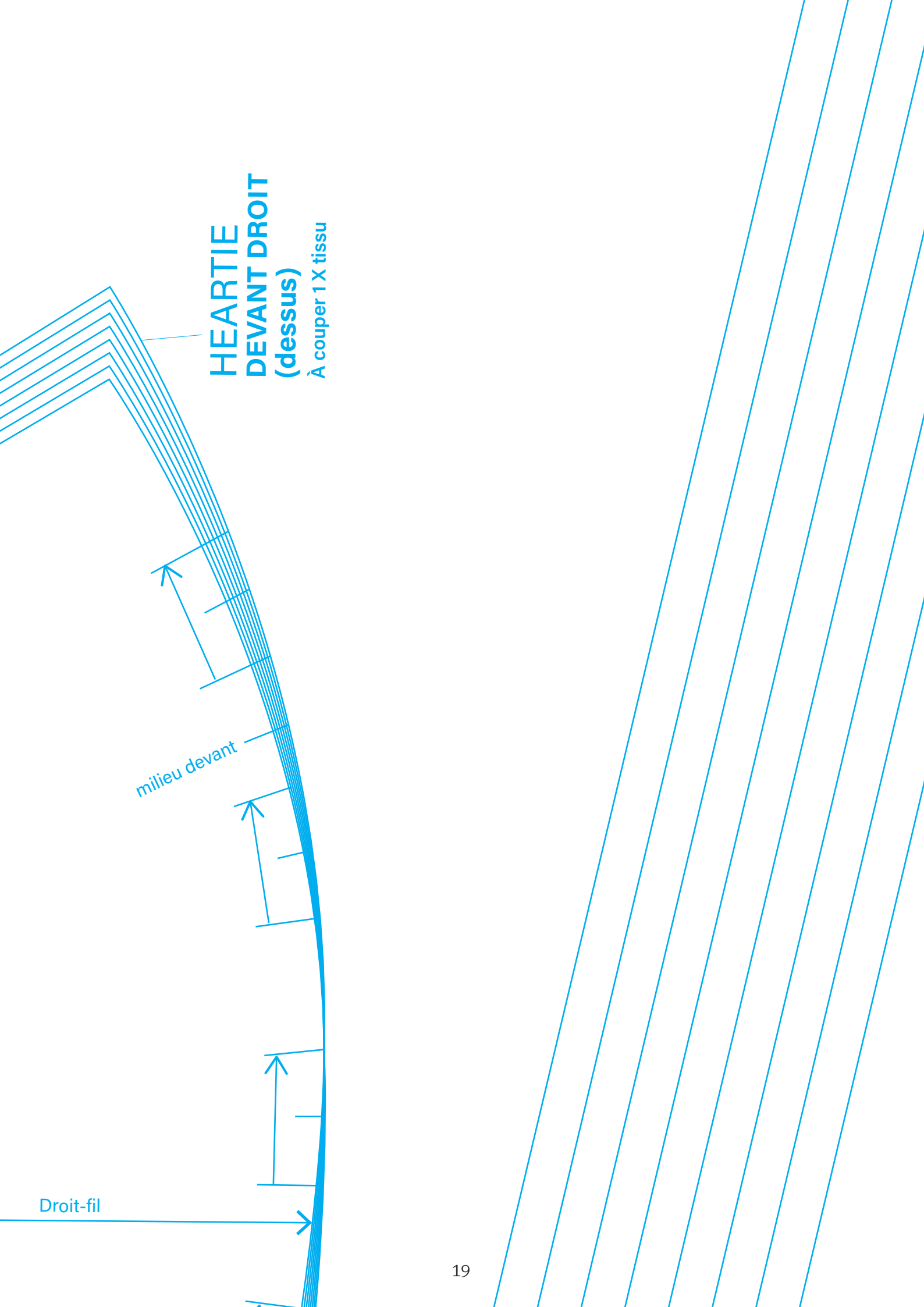

**HEARTIE
DEVANT DROIT
(dessus)**

À couper 1 X tissu

milieu devant

Droit-fil



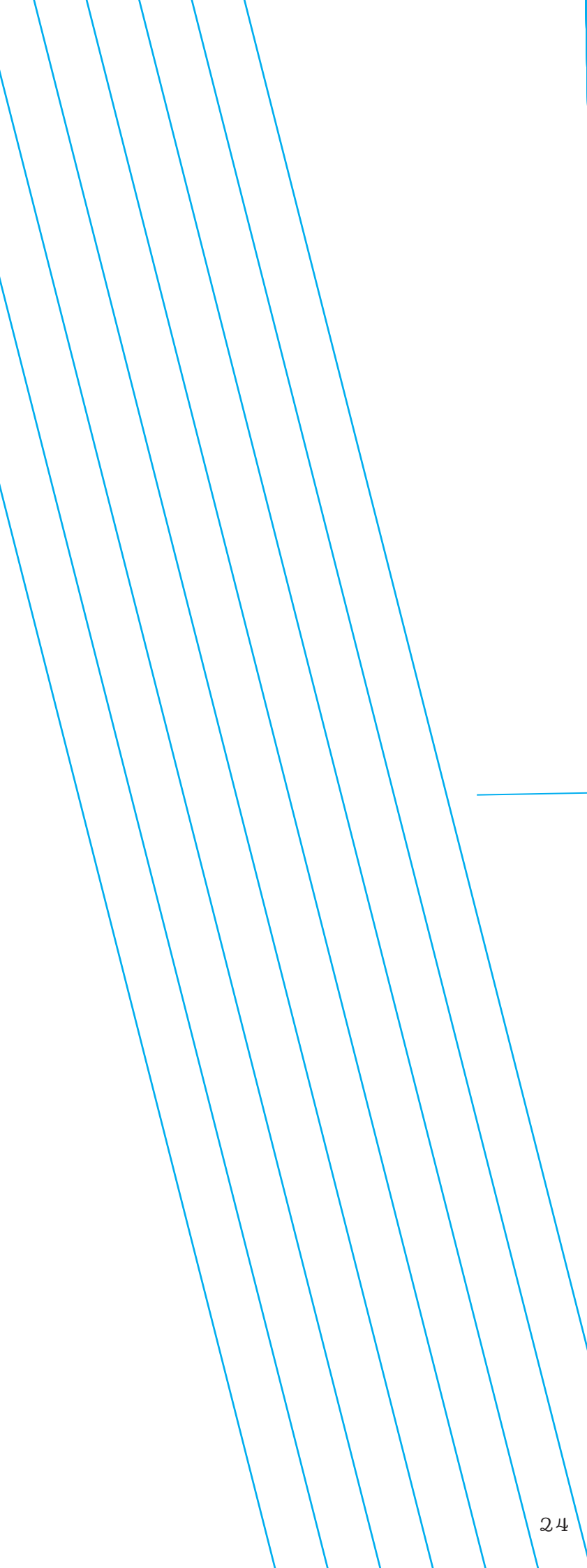

repère
pour
l'ouverture

ligne de raccord

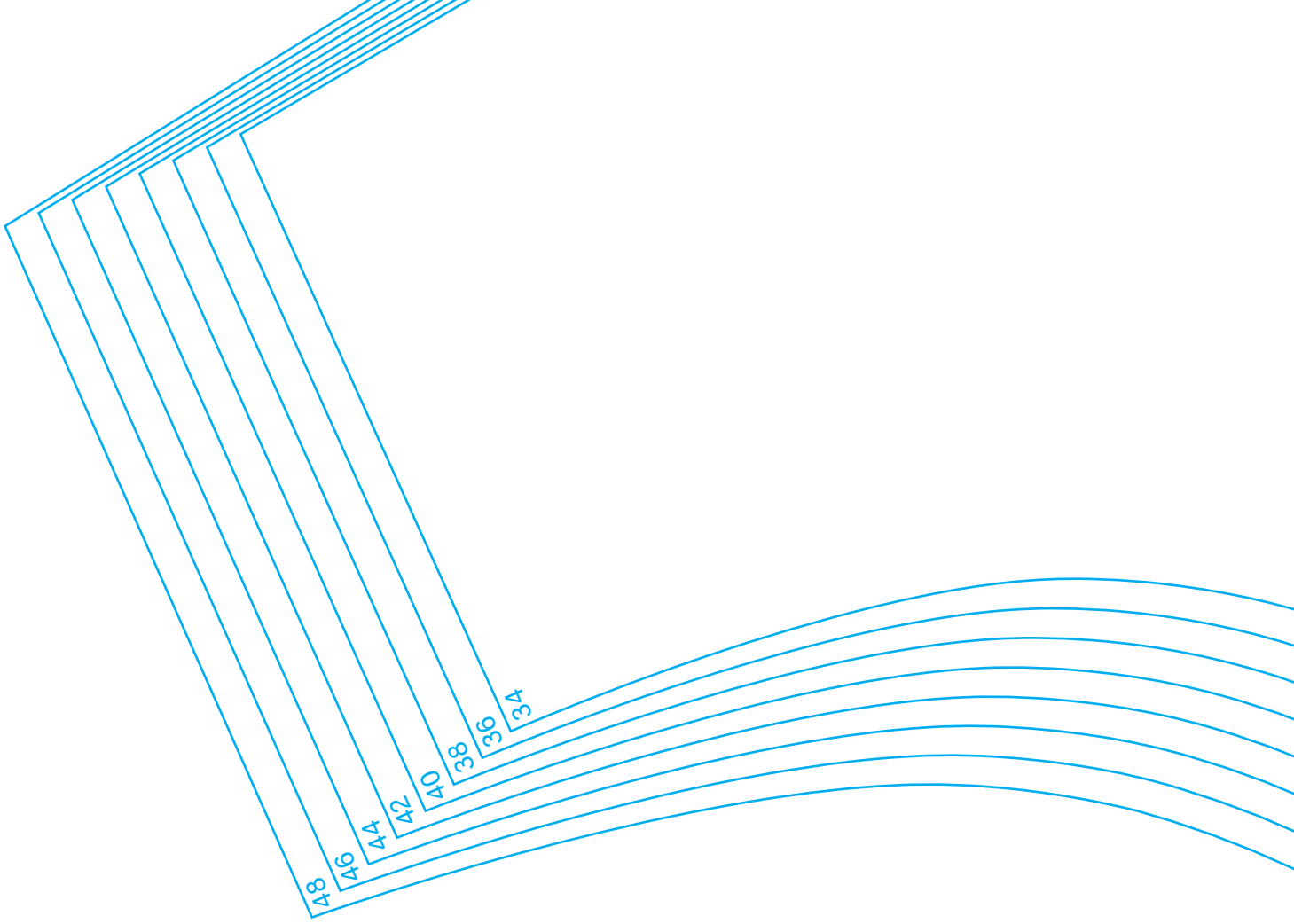

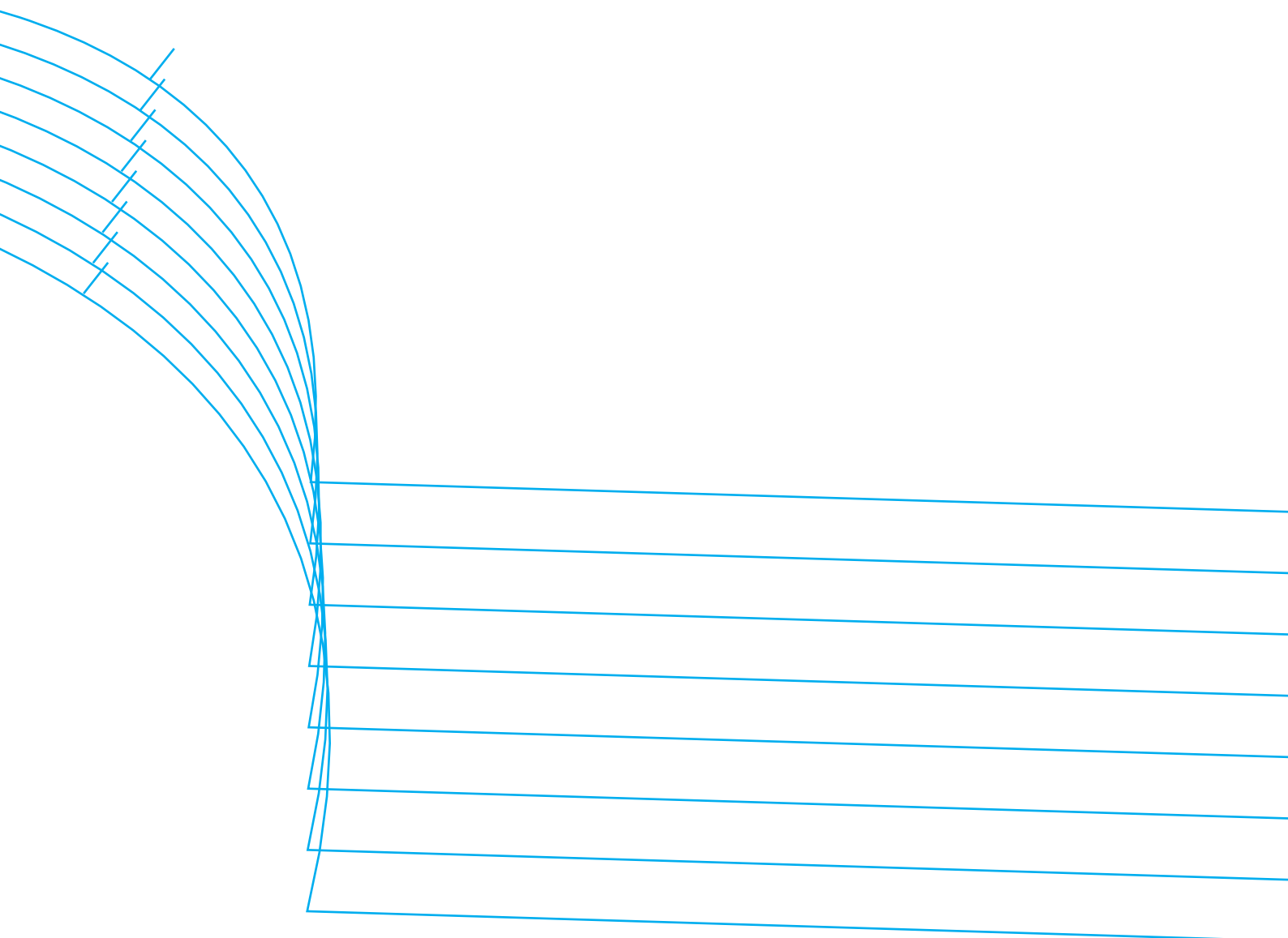

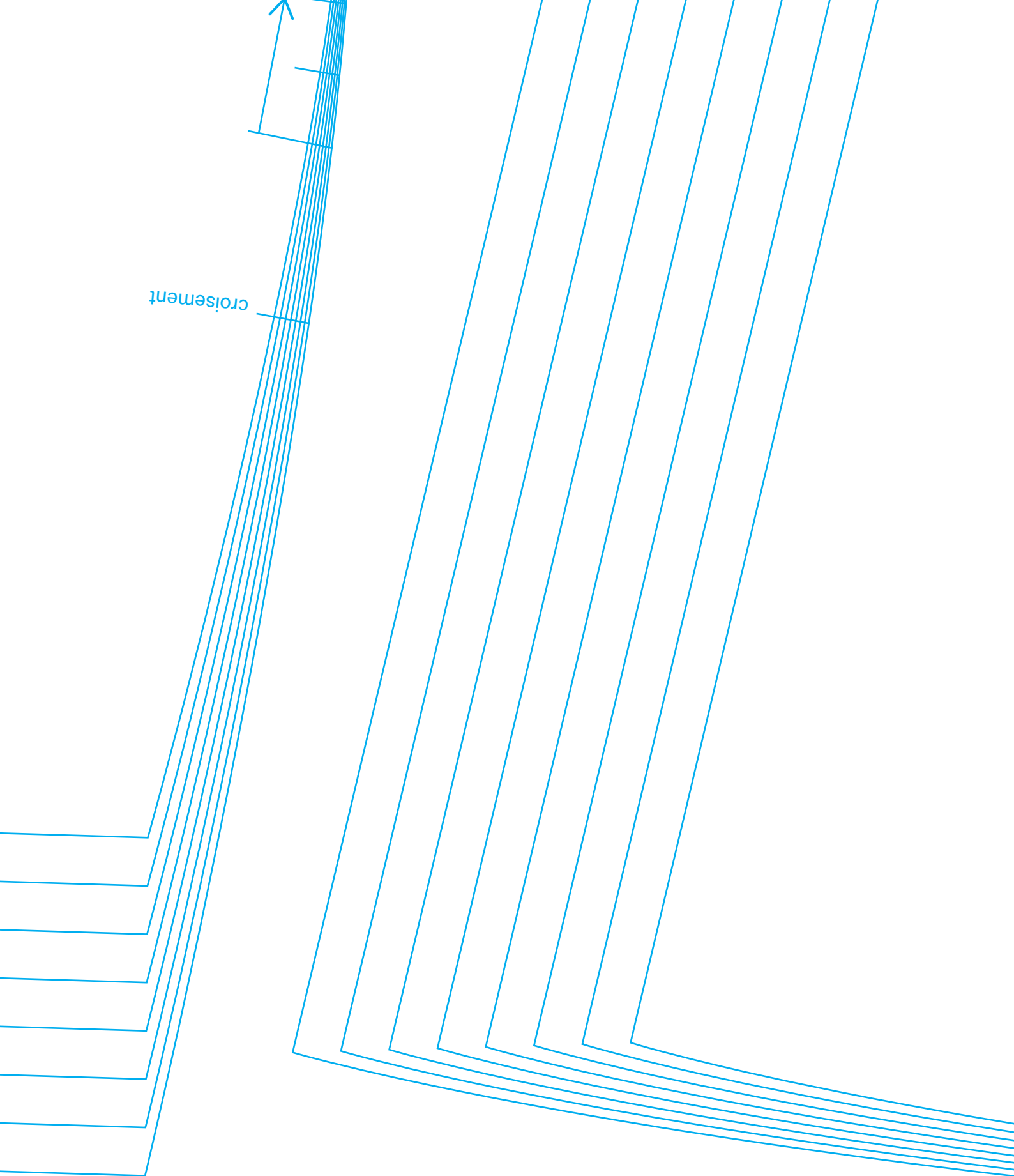



longueur robe

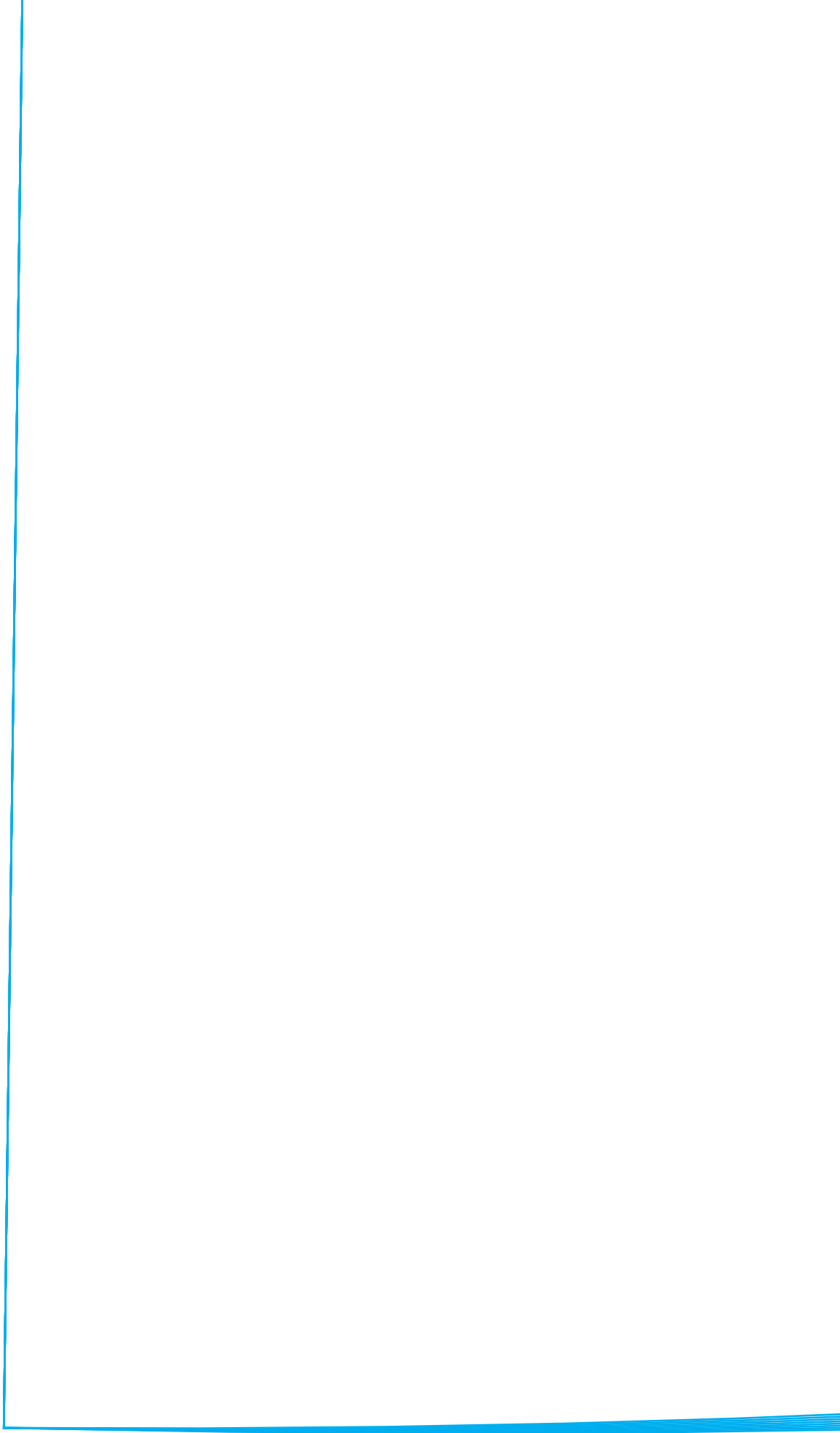

longueur robe

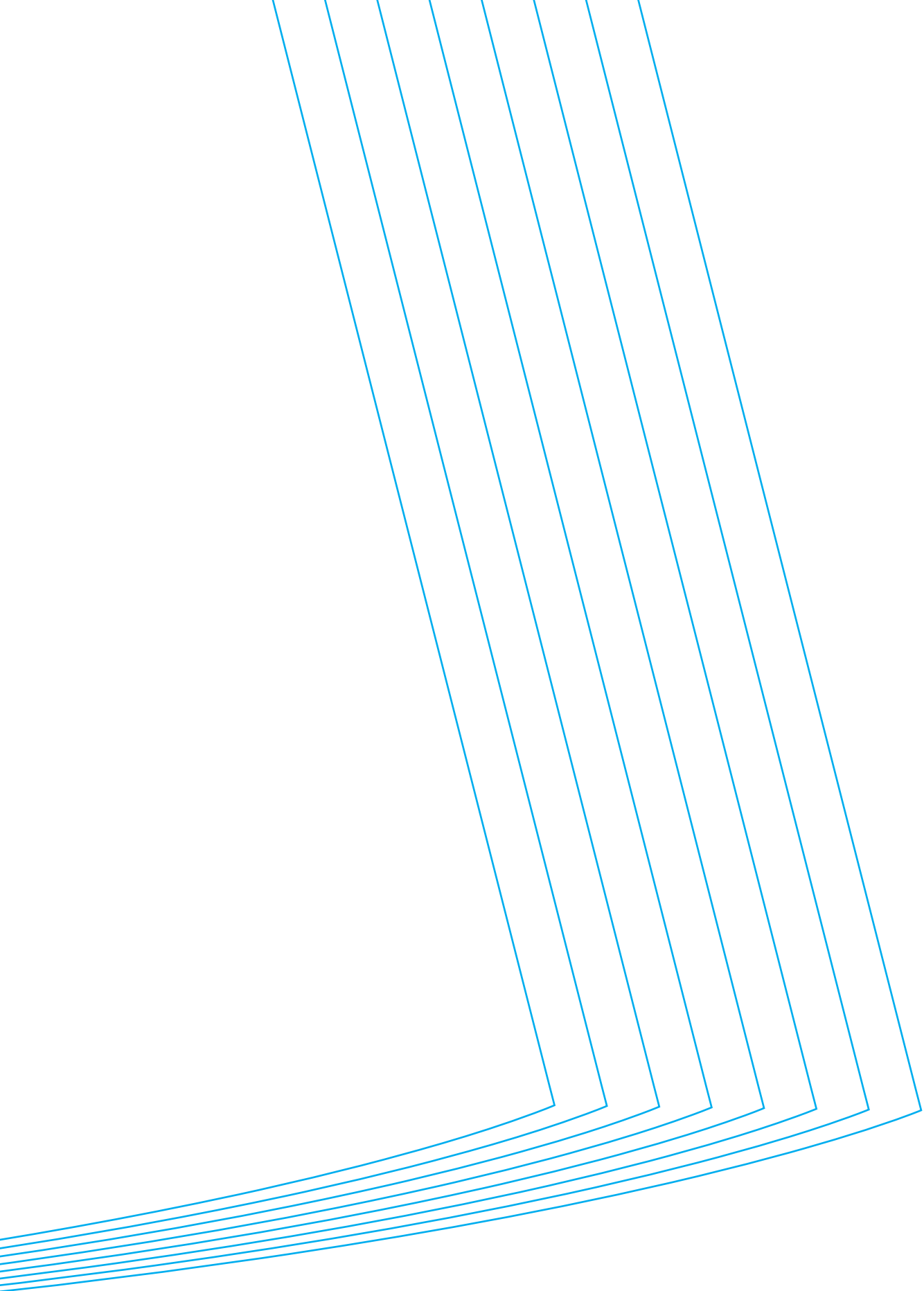

48
46
44
42
40
38
36
34



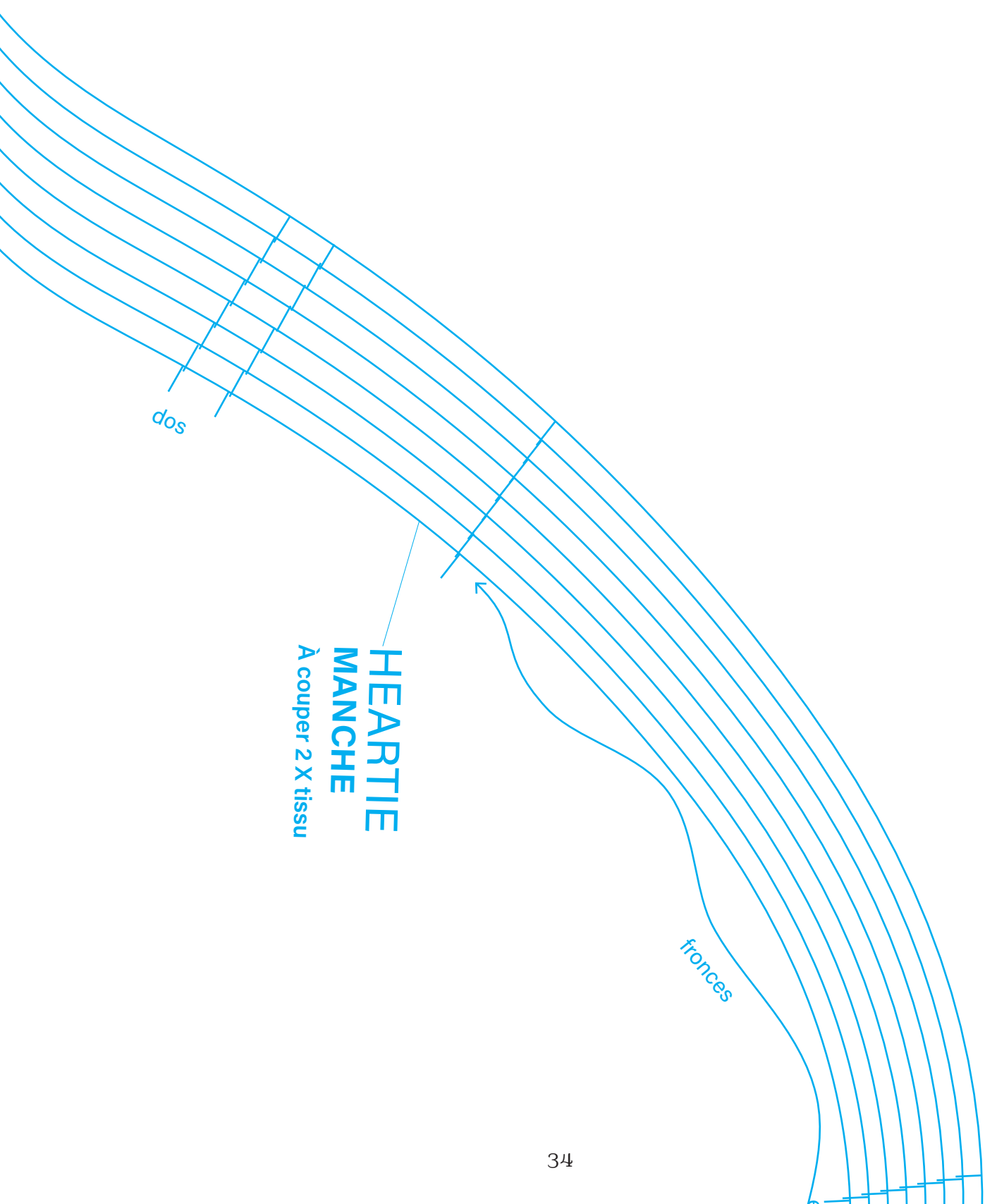

dos

**HEARTIE
MANCHE**
À couper 2 X tissu

fronces

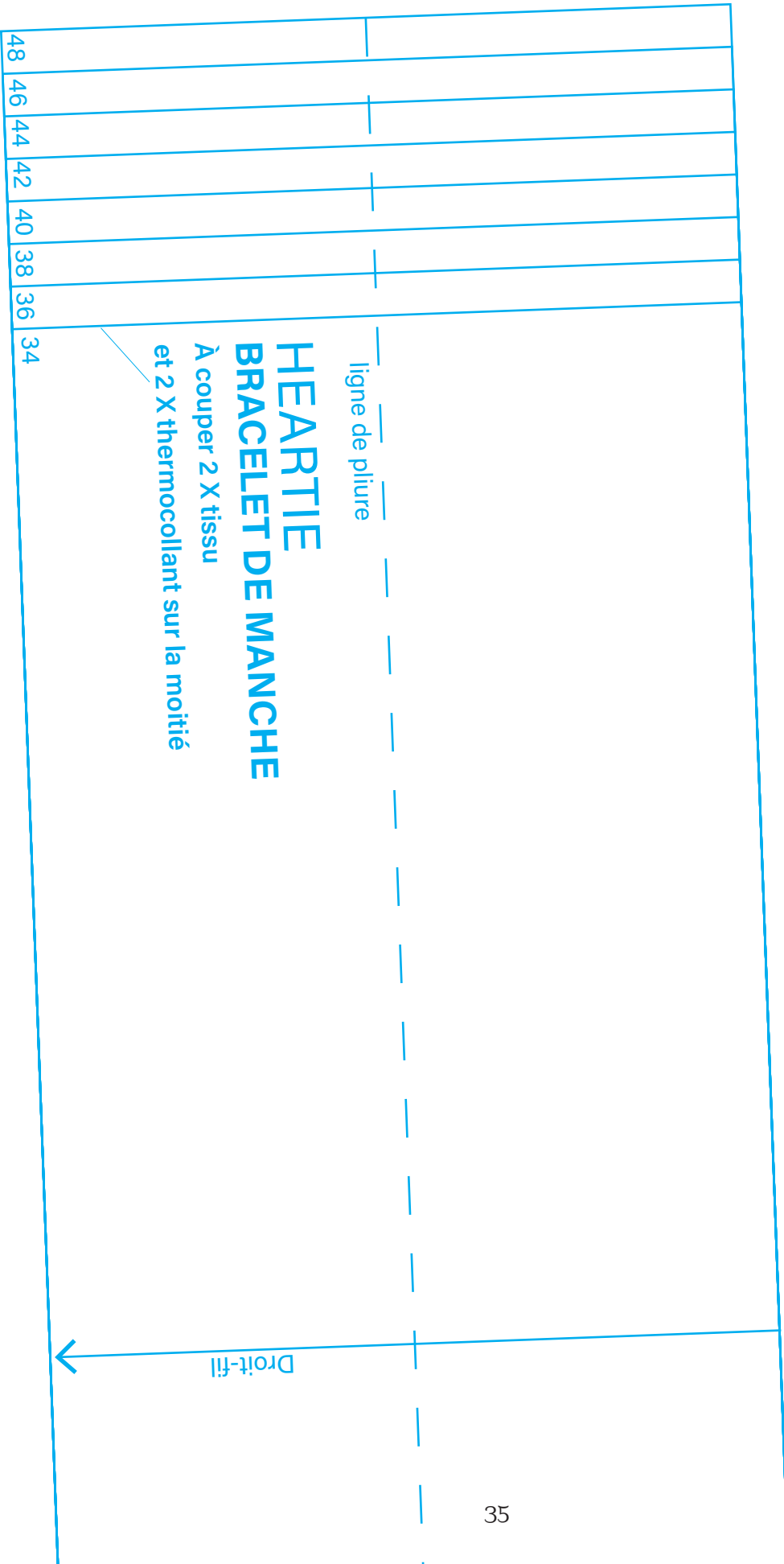

ligne de raccord

34

36

38

36

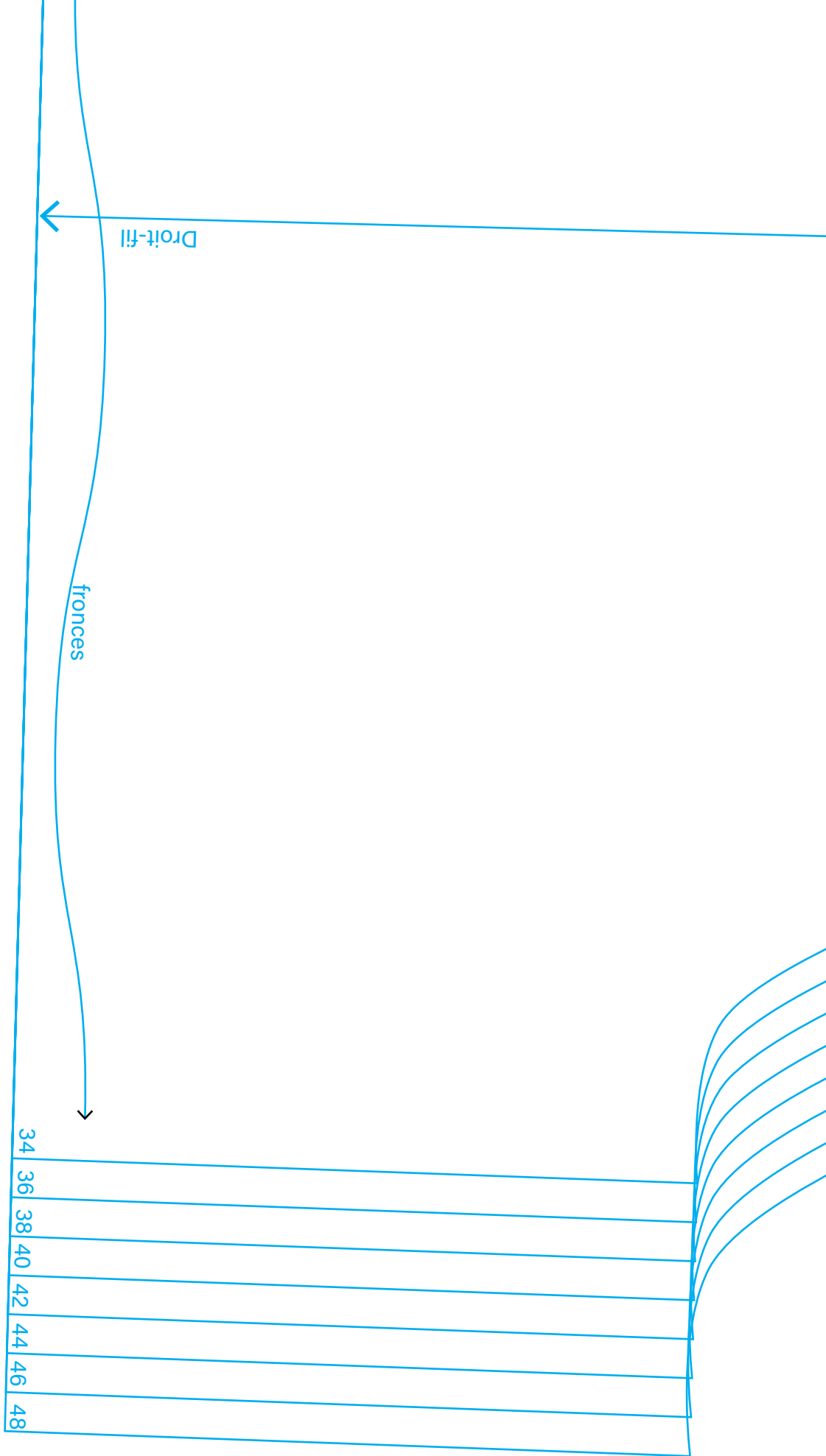

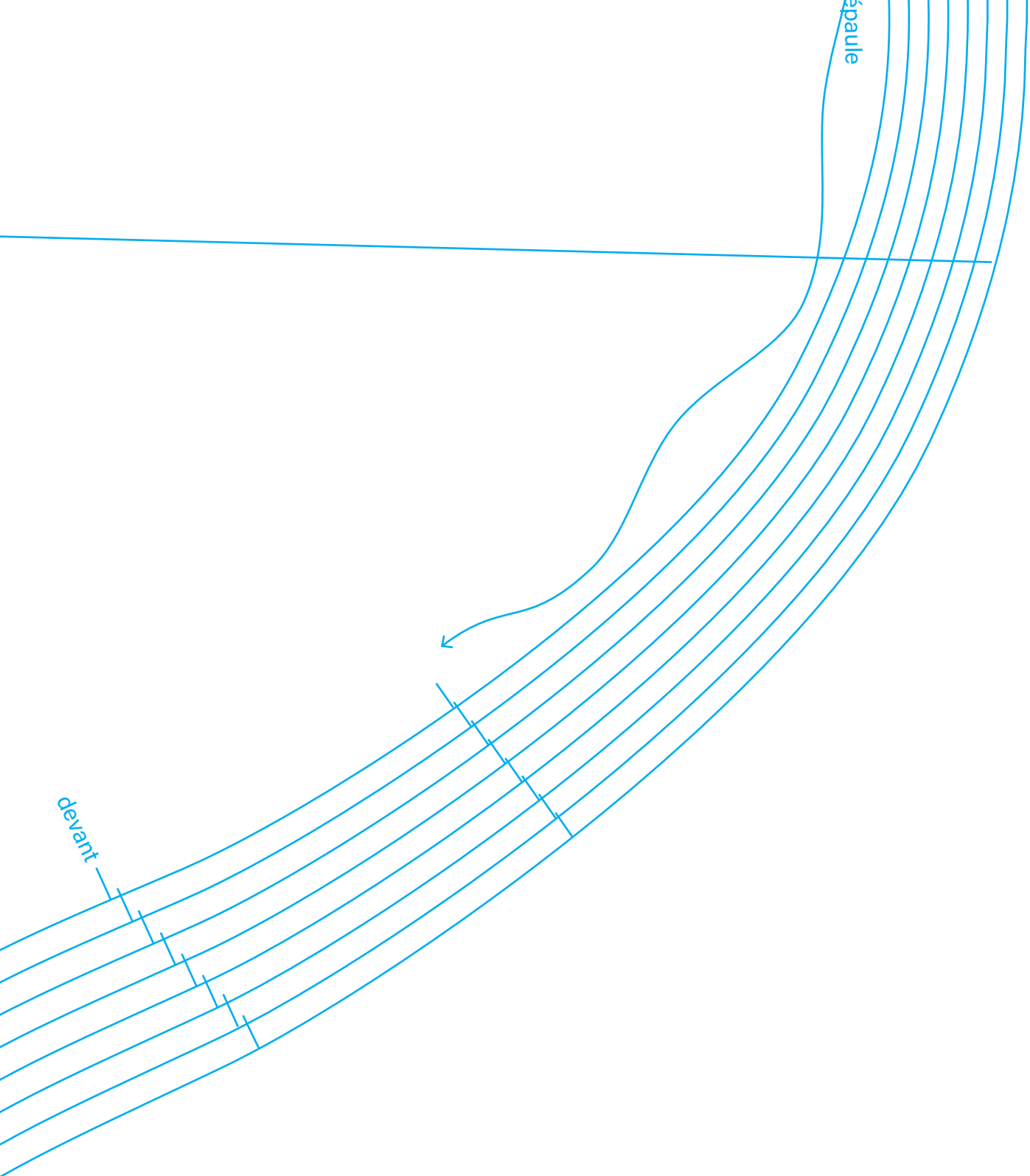

Handwriting practice lines with a dashed midline and solid outer lines. The page is divided into seven horizontal rows. The left side of each row contains a number, and the right side is a blank space for writing. The numbers are 34, 36, 38, 40, 42, 44, 46, and 48, arranged vertically from top to bottom.

34	
36	
38	
40	
42	
44	
46	
48	

HEARTIE CEINTURE

À couper 2 X tissu
et 1 X thermocollant

Pièce coupée
en 2 (partie 2/2)

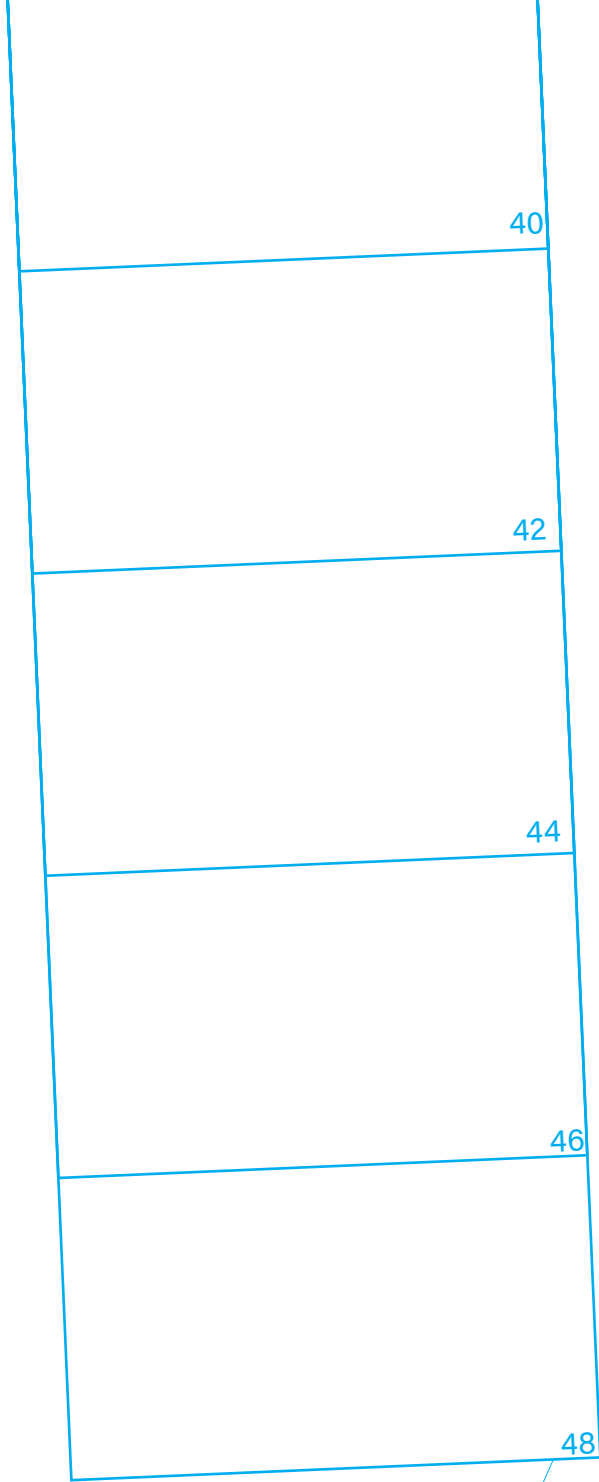

Mon joli dressing

Célia Moreau
@little_c_celia

Carré d'essai
5 x 5 cm

Patron à reconstituer

Nos patrons sont à imprimer sur du papier format A4.
Les pages sont numérotées. Les assembler bord à bord
avec du ruban adhésif. Il y a lieu de prolonger les lignes
d'une page sur l'autre avant de couper les patrons.

Schéma de montage

1	2	3	4	5	6
7	8	9	10	11	12
13	14	15	16	17	
18	19	20	21	22	

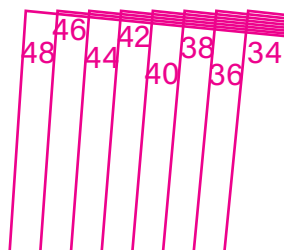

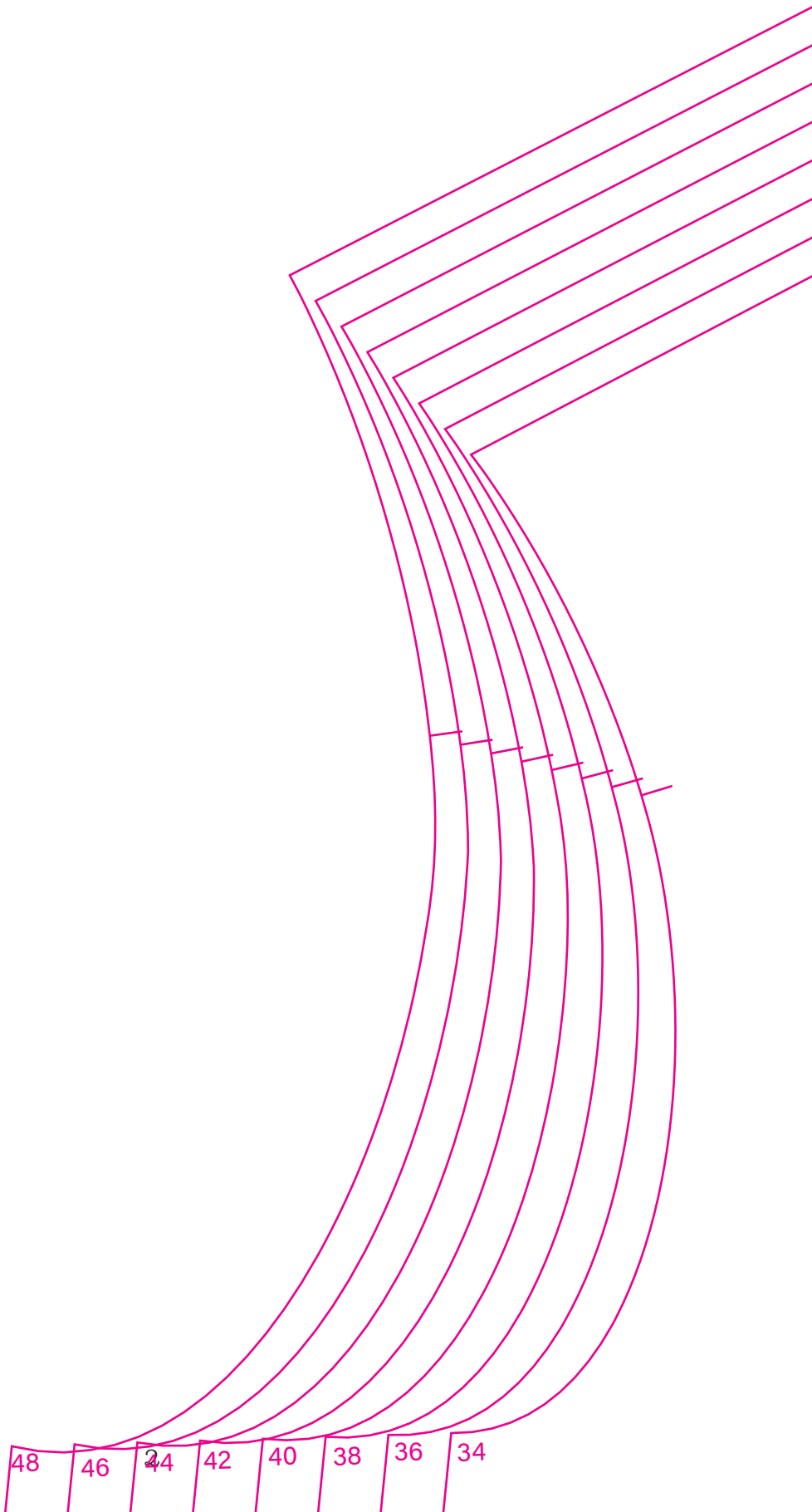

48 46 44 42 40 38 36 34

Droit-fil

GIRLY
BIAIS DE LA GOUTTE
À couper 1 X tissu

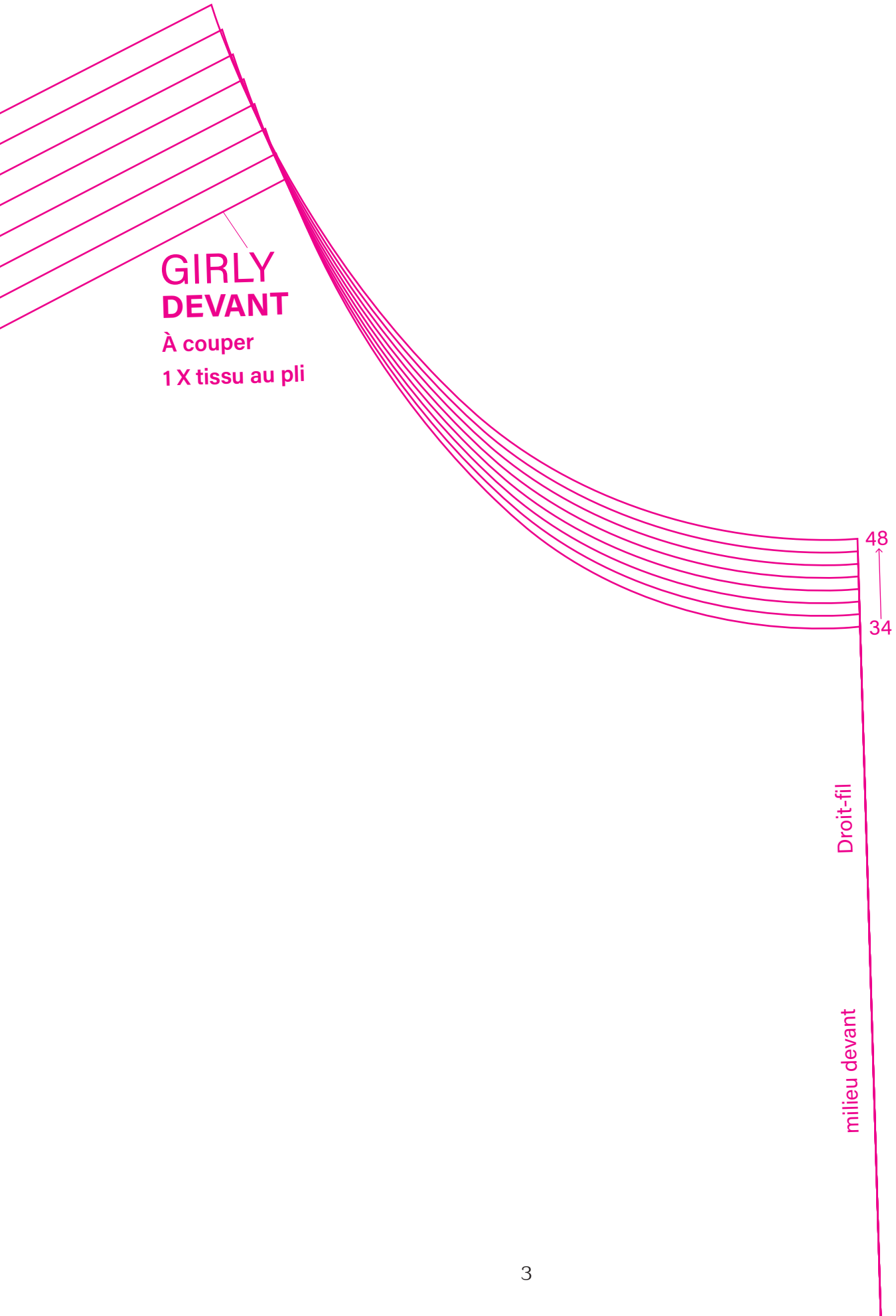

**GIRLY
DEVANT**

À couper
1 X tissu au pli

48

34

Droit-fil

milieu devant

48	46	44	42	40	38	36	34
----	----	----	----	----	----	----	----

GIRLY

BANDE FROUFROU DU CORPS

À couper 2 X tissu au pli

ligne de fronces

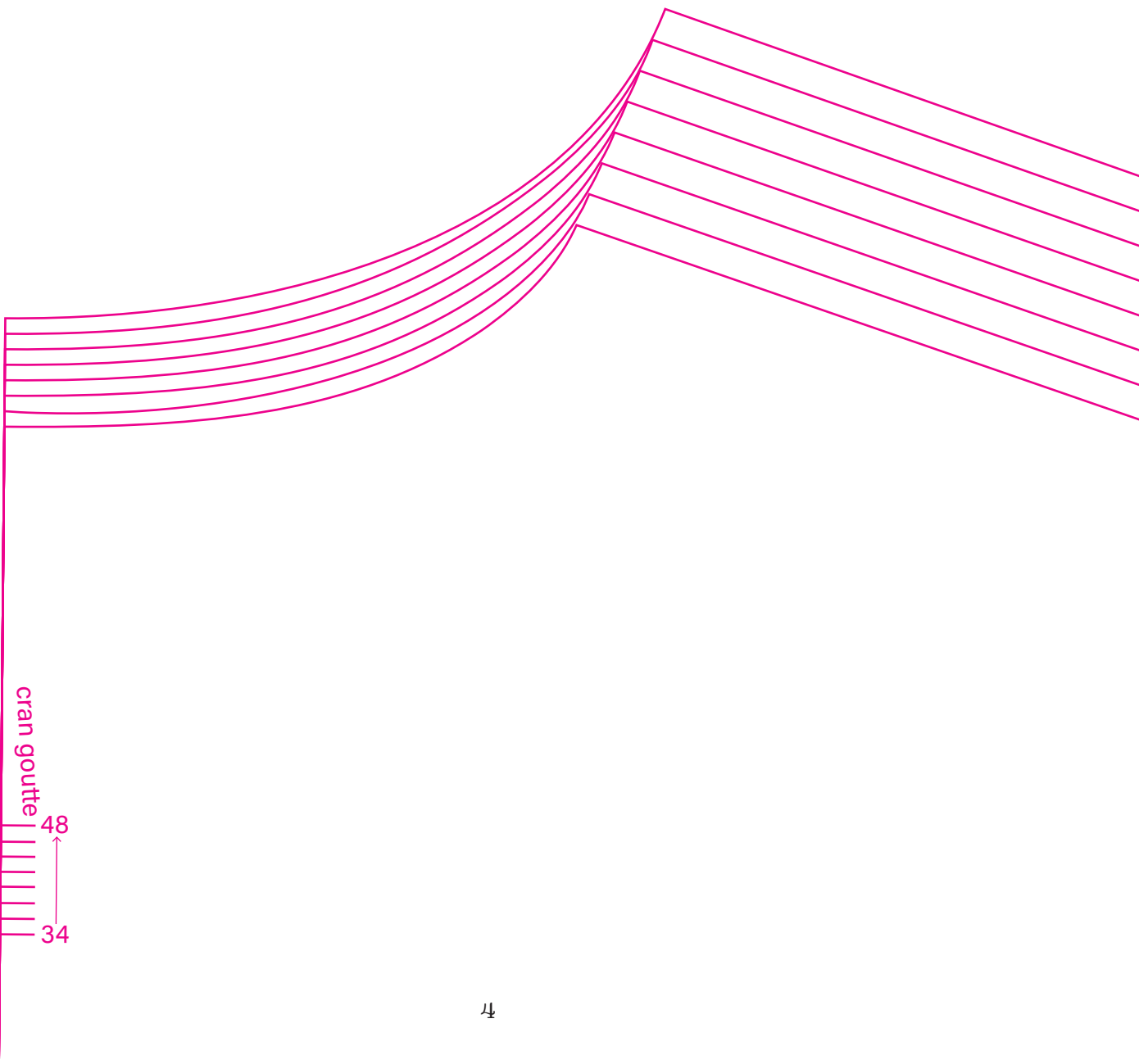

**GIRLY
BANDE FROUFROU DE**
À couper 2 X tissu au pli



**GIRLY
DOS**
À couper 1 X tissu au pli

**GIRLY
BRIDE**
À couper 1 X tissu

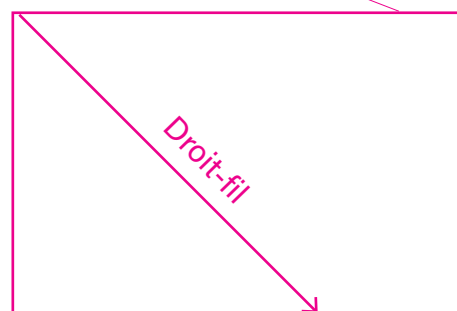

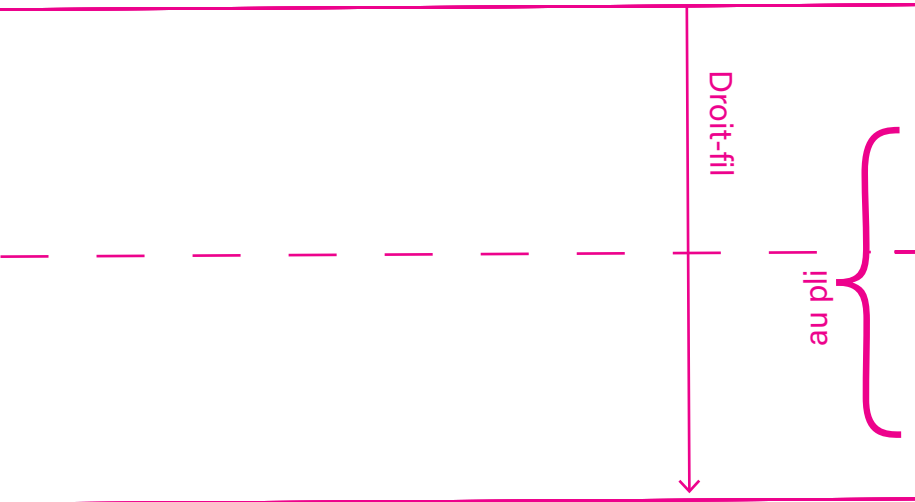

LA MANCHE

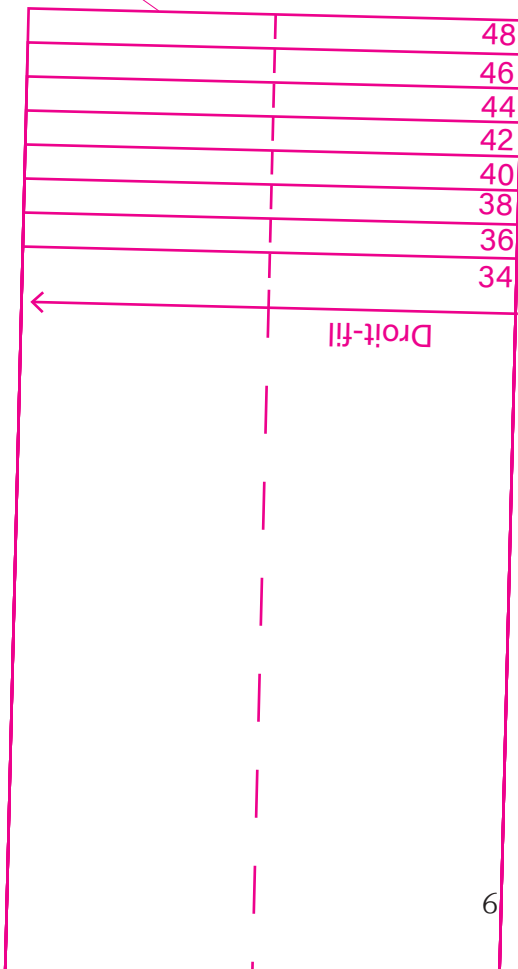

A pink patterned sleeve cuff pattern consisting of multiple parallel lines that curve from a narrow opening at the top to a wider opening at the bottom. The pattern is drawn on a white background.

**GIRLY
BAS DE MANCHE**

À couper 2 X tissu au pli

au pli



Droit-fil

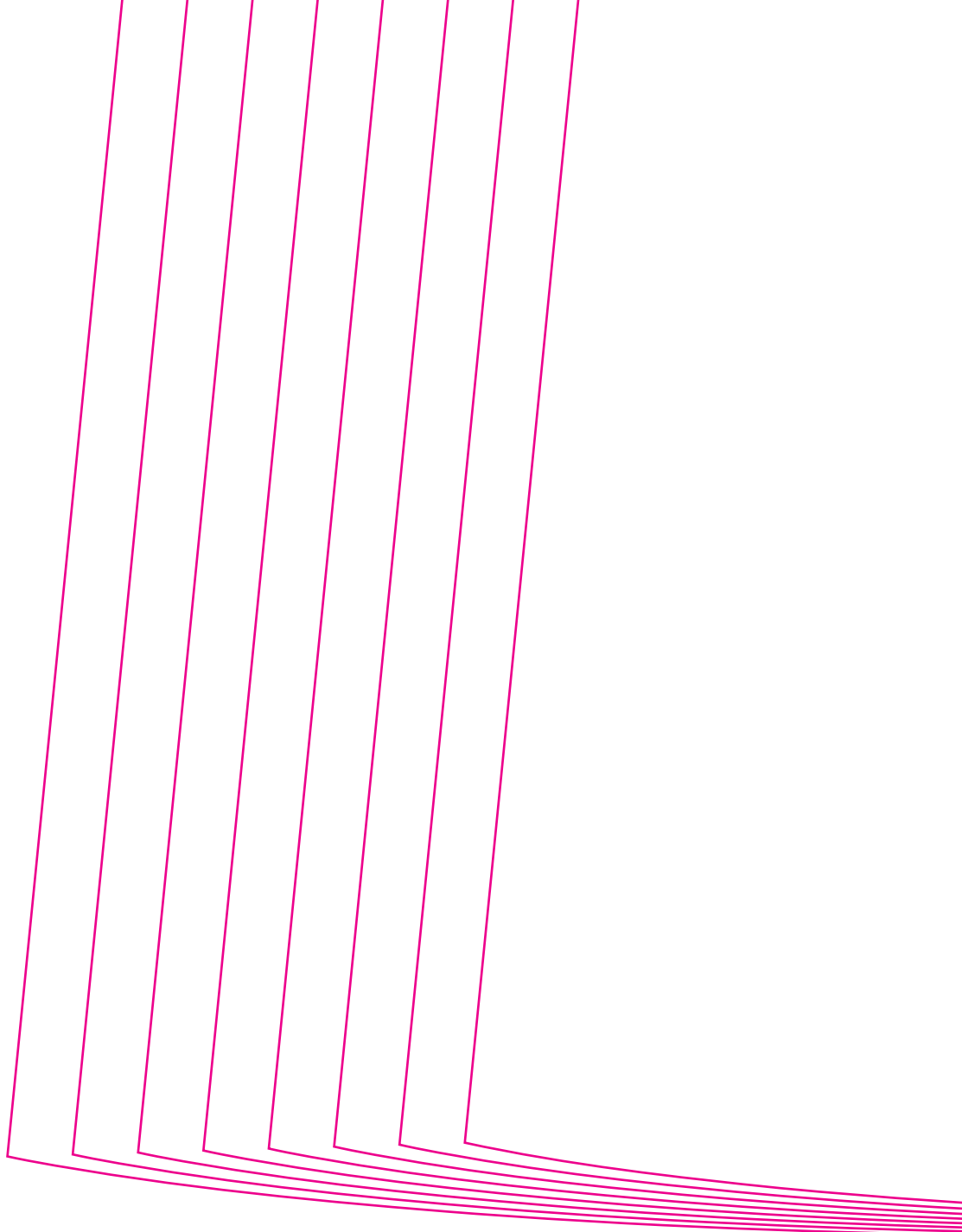

Au pli



Droit-fil

milieu dos

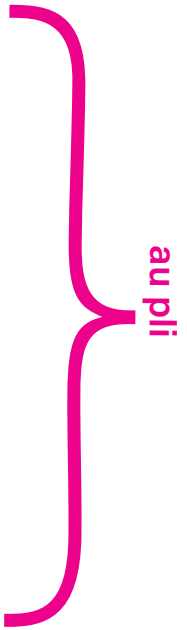

au pli

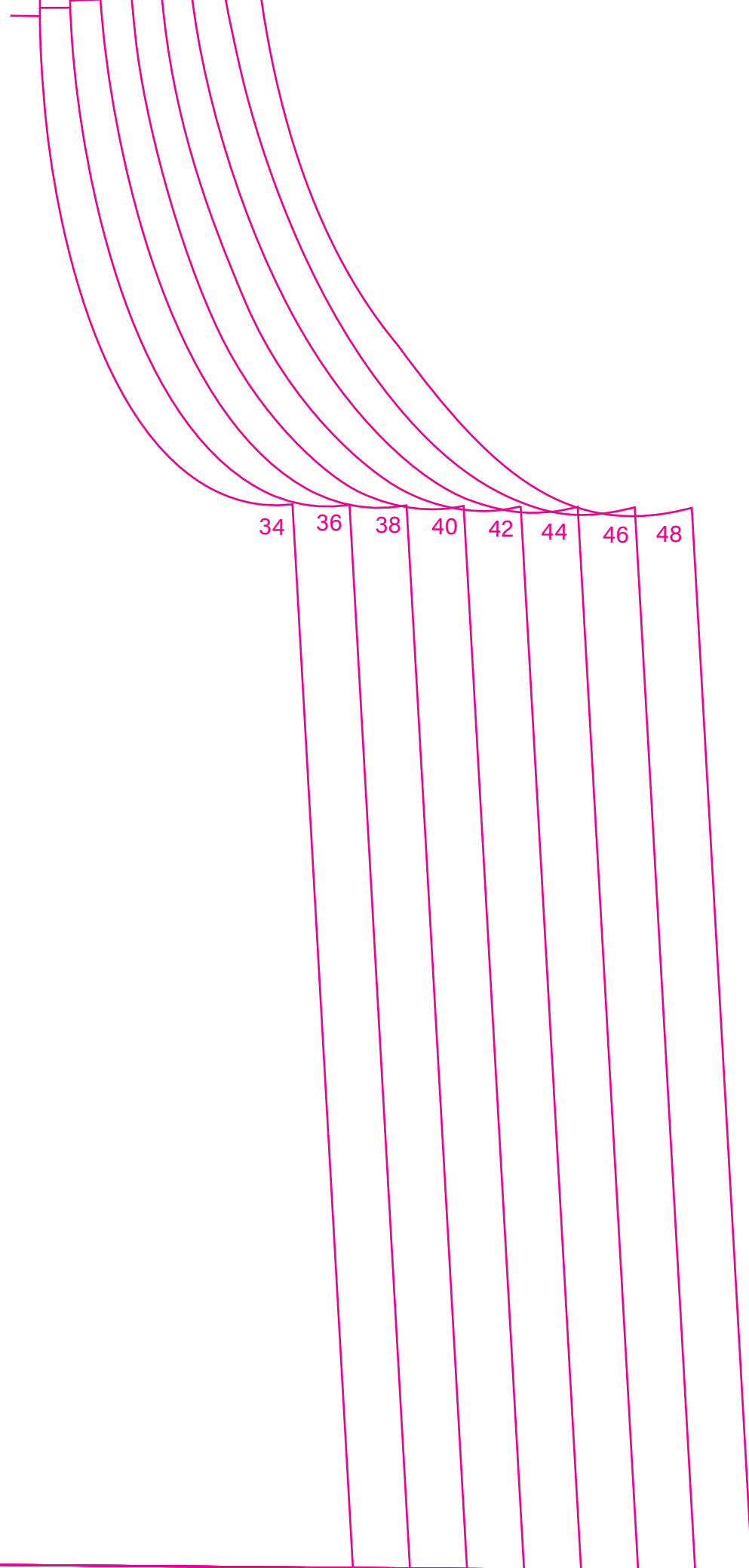

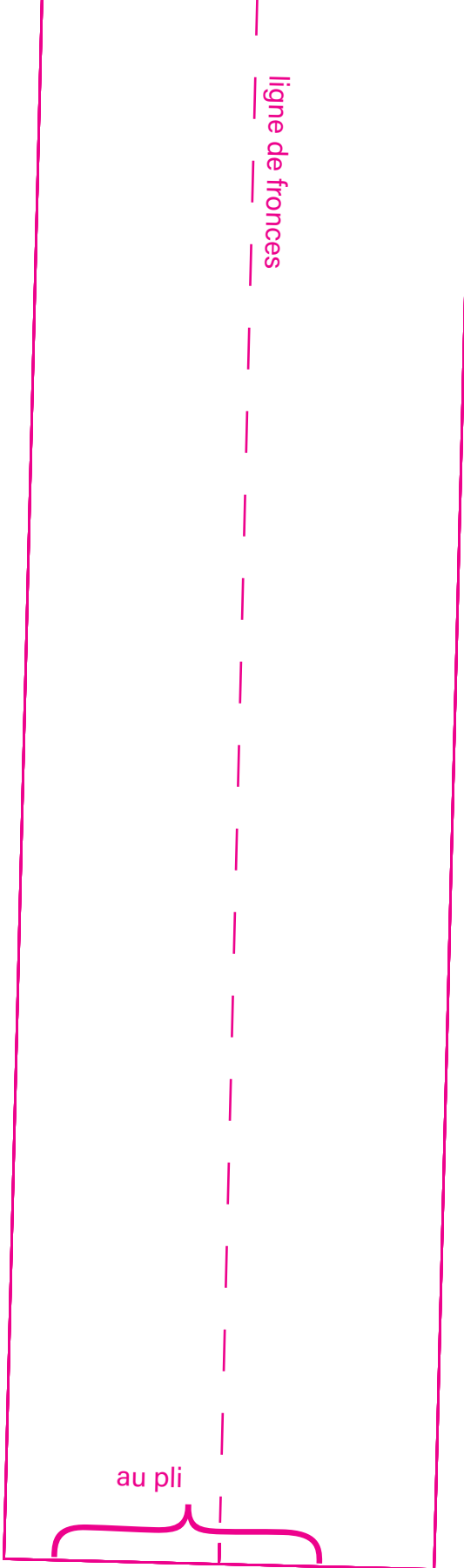

GIRLY JUPES DEVANT et DOS

À couper 2 X tissu au pli

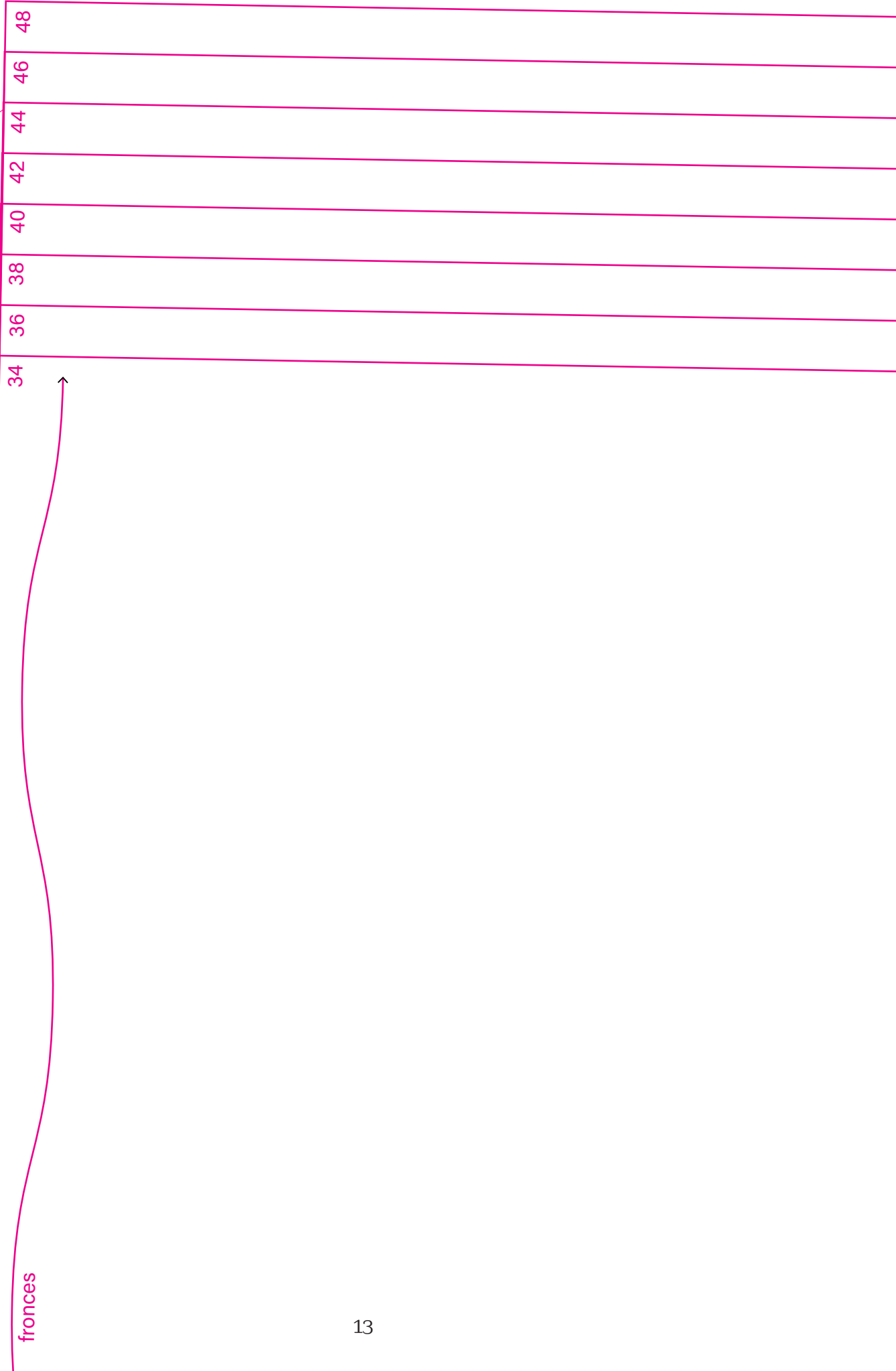

fronces



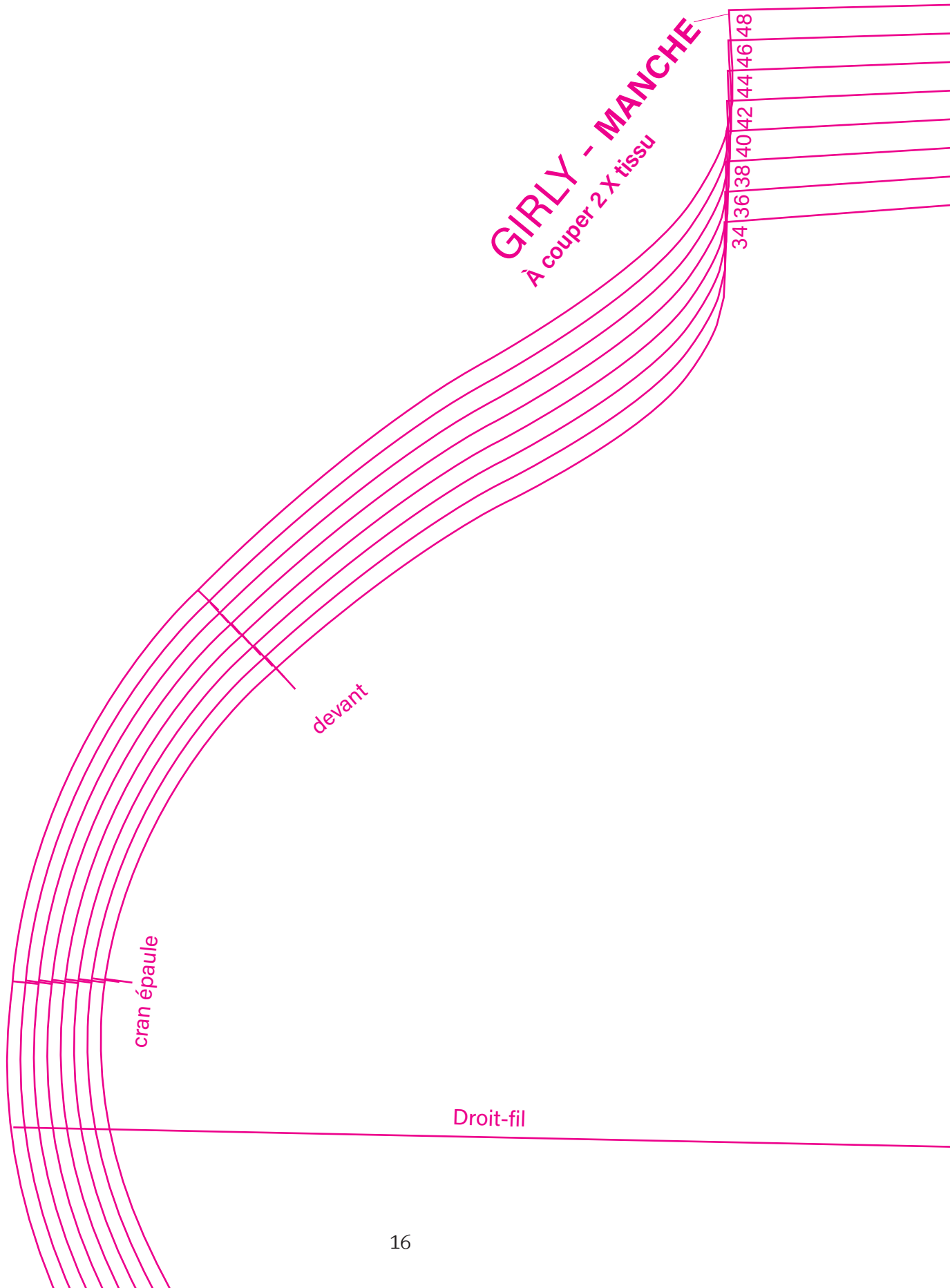

GIRLY - MANCHE
À couper 2X tissu

34 36 38 40 42 44 46 48

cran épaule

devant

Droit-fil



au pli



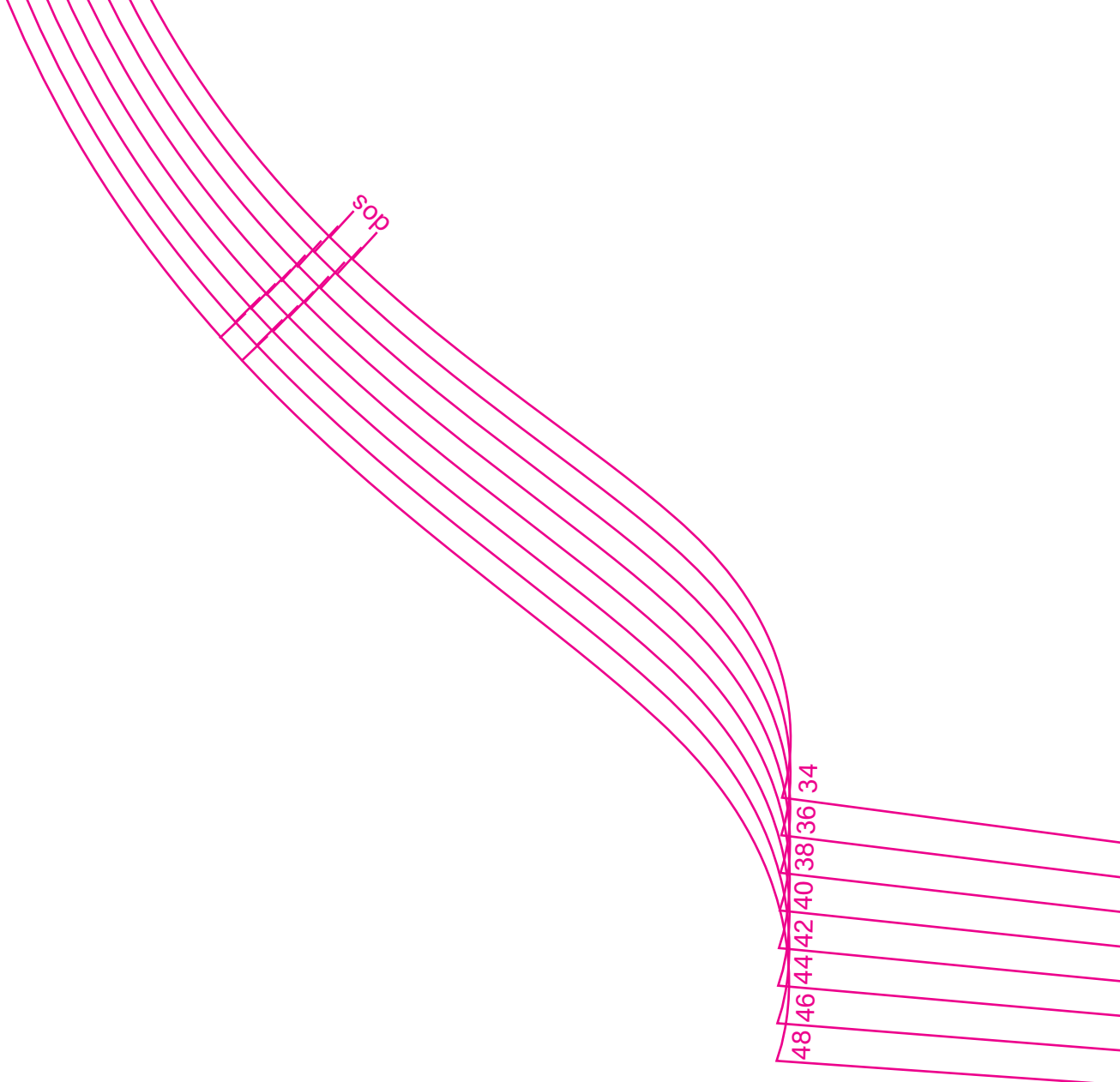



Mon joli dressing

Célia Moreau
@little_c_celia

Carré d'essai
5 x 5 cm

Patron à reconstituer

Nos patrons sont à imprimer sur du papier format A4.
Les pages sont numérotées. Les assembler bord à bord
avec du ruban adhésif. Il y a lieu de prolonger les lignes
d'une page sur l'autre avant de couper les patrons.

Schéma de montage

1	2	3	4	5	6	7	8
9	10	11	12	13	14	15	16
17	18	19	20	21	22	23	24
25	26	27	28	29	30	31	32
33	34	35	36	37	38		
39	40	41	42	43	44		

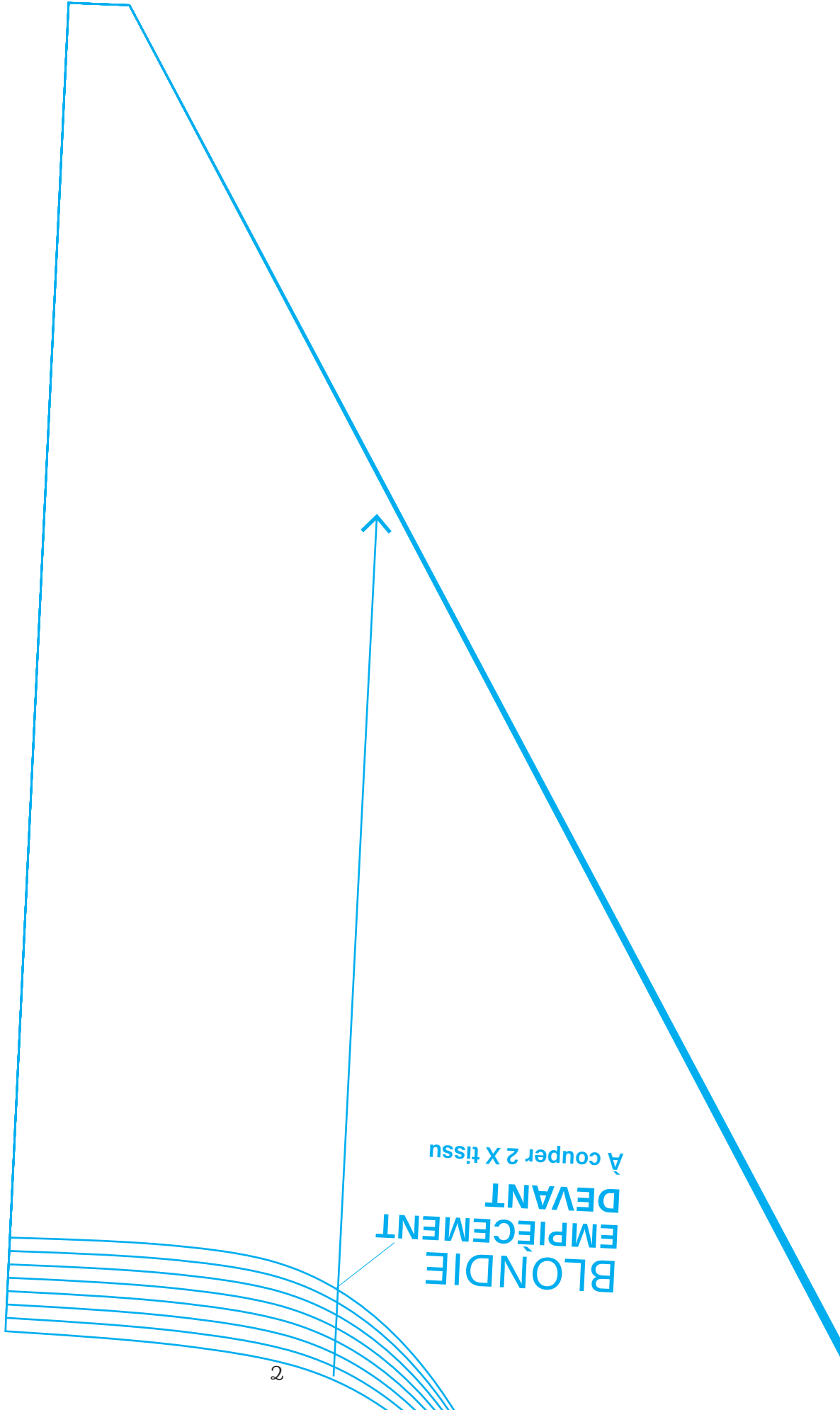

BLONDIE
EMPIÈCEMENT
DEVANT
À couper 2 X tissu

48	
46	
44	
42	
40	
38	
36	
34	Droit-fill

BLONDIE - VOLA
À couper 2 X tissu

Droit-fill

fronces

ourlet

NT

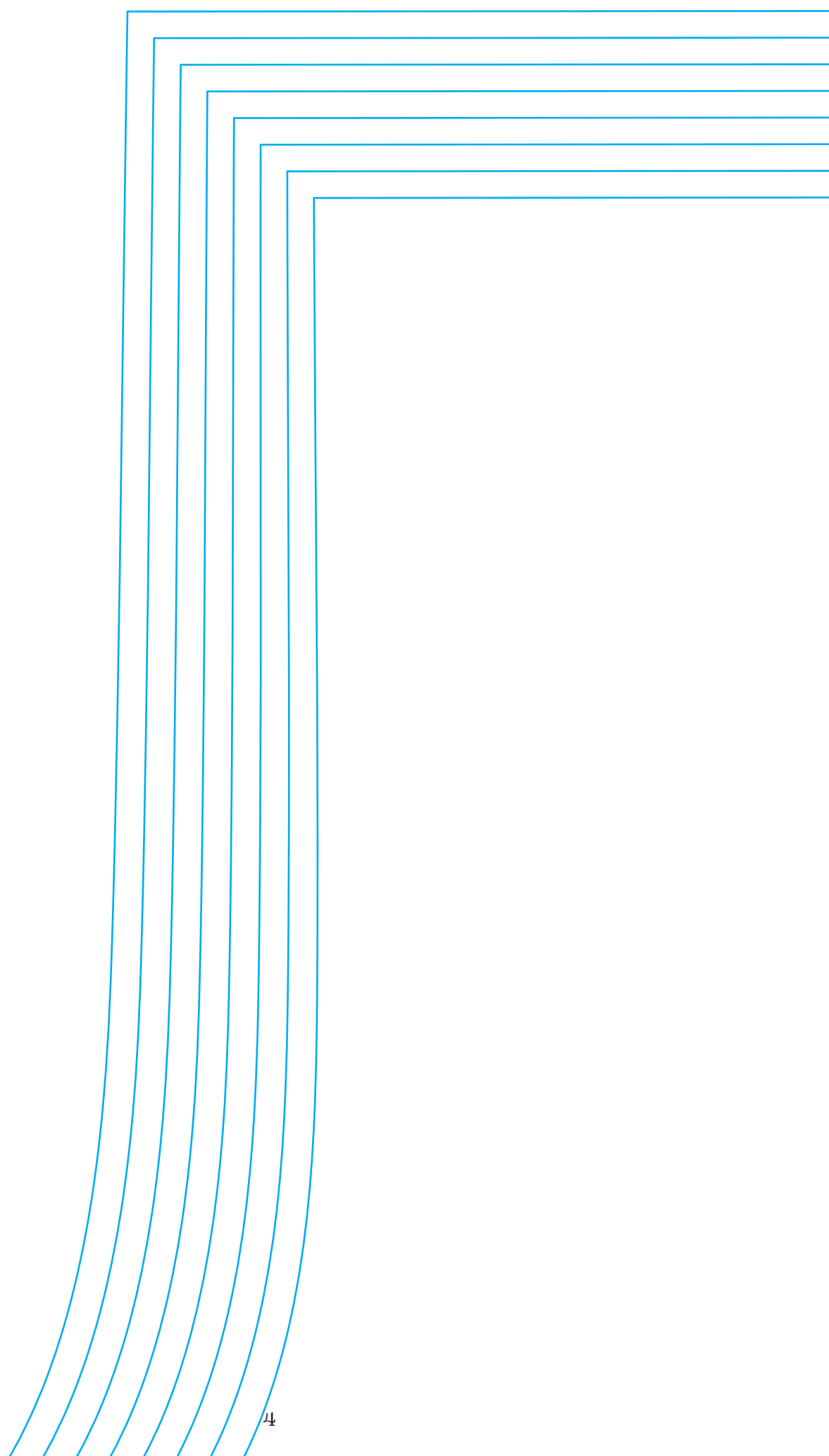

BLONDIE

JAMBE DEVANT

À couper 2 X tissu

Pièce coupée en 2 (partie 1/2)

repère
poche

34
36
38
40
42
44
46
48

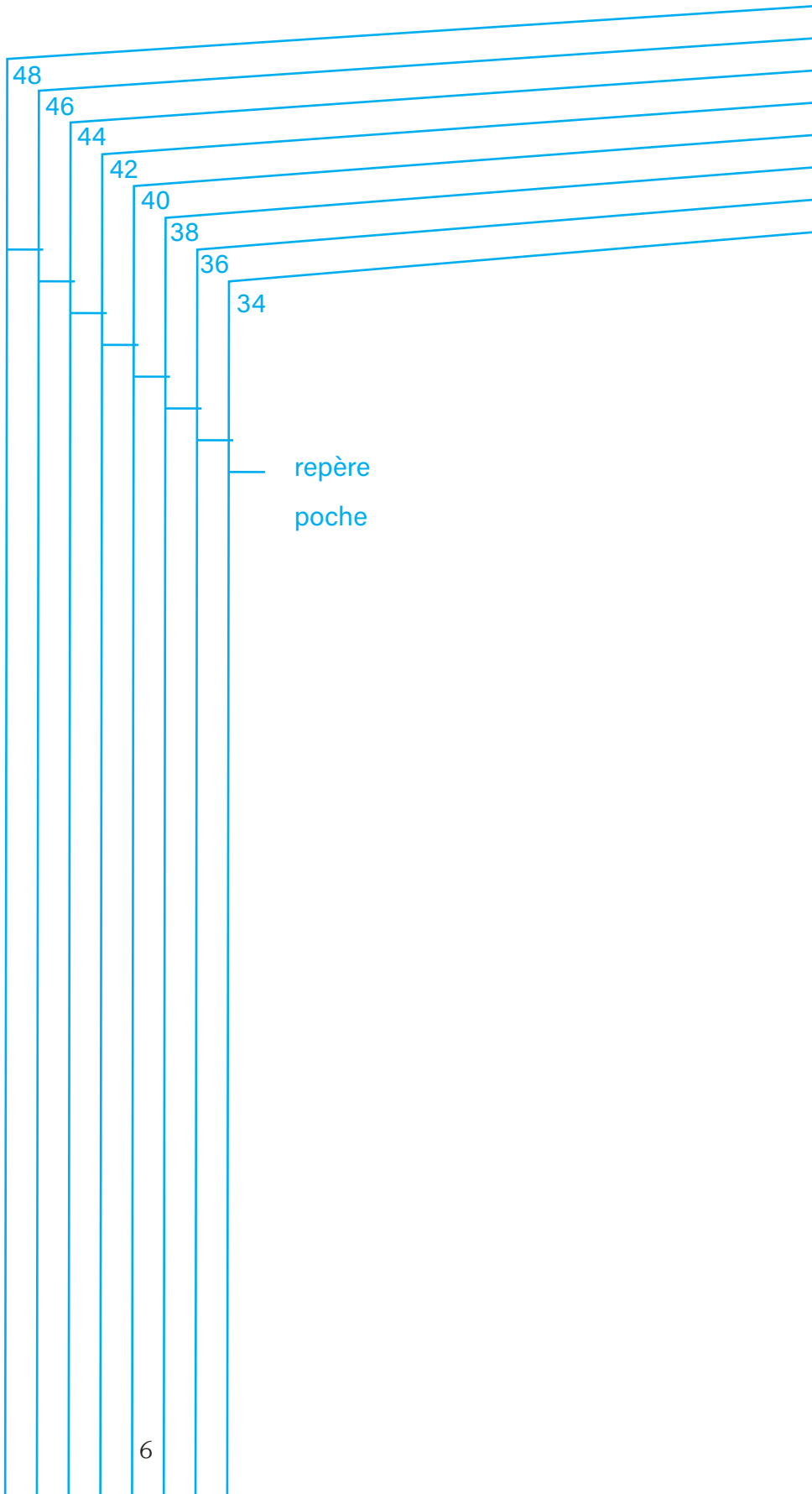

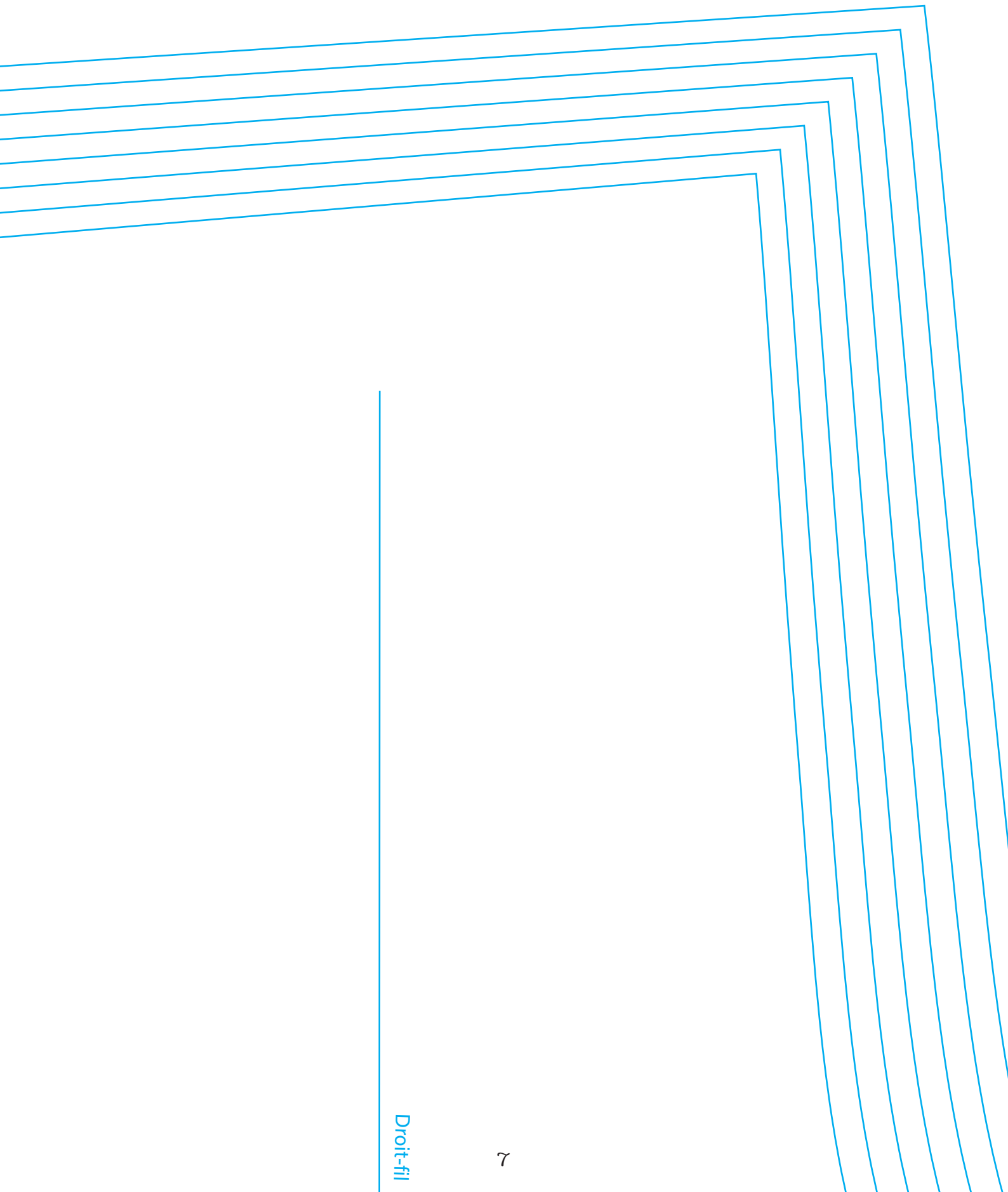

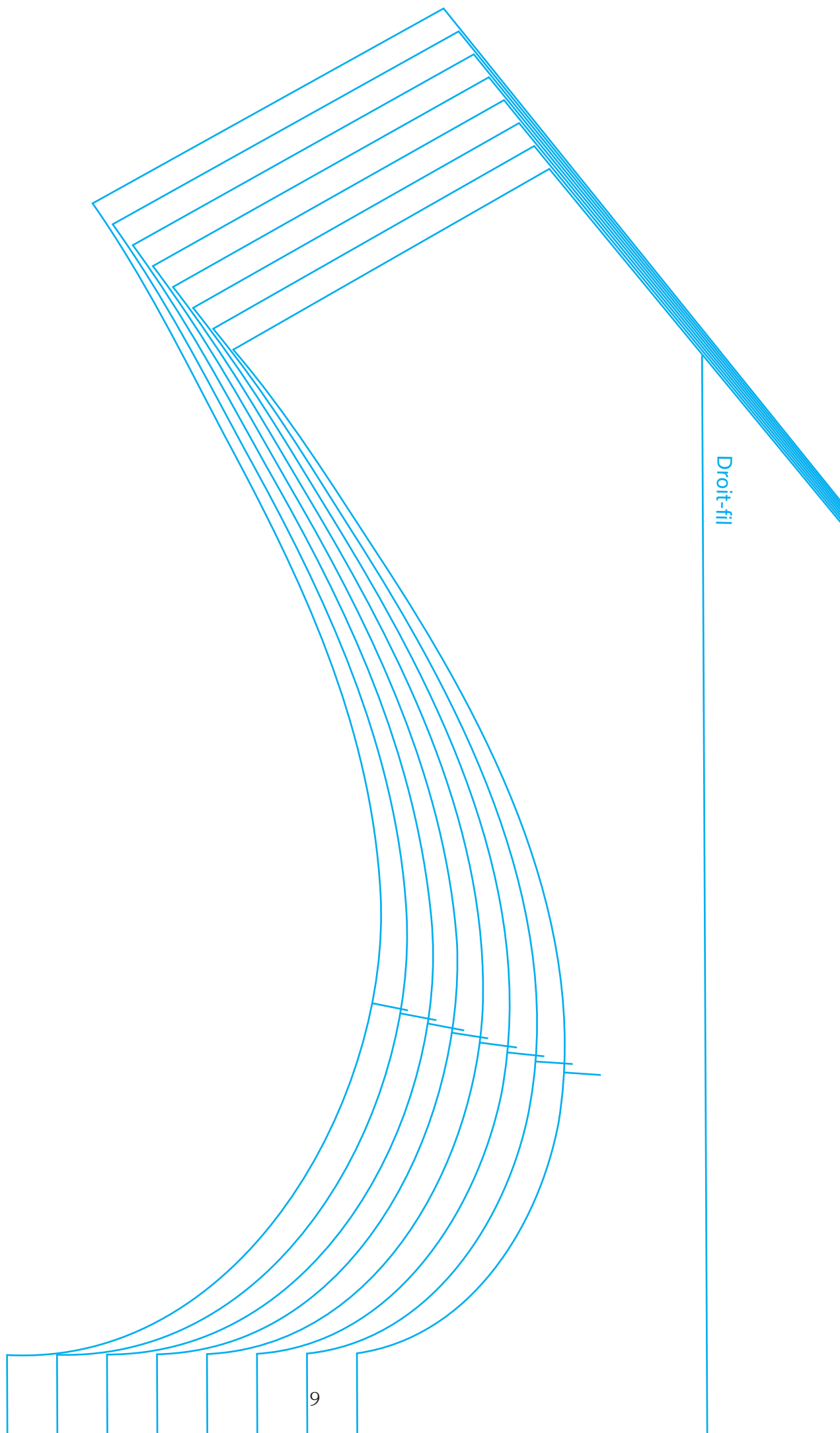

Droit-fil

34
36
38
40
42
44
46
48

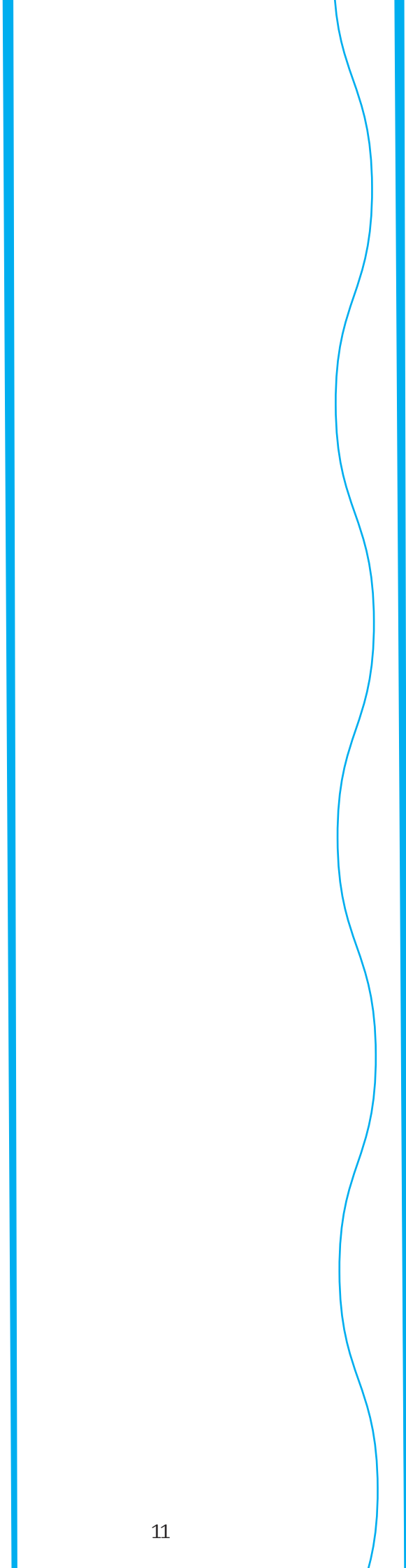
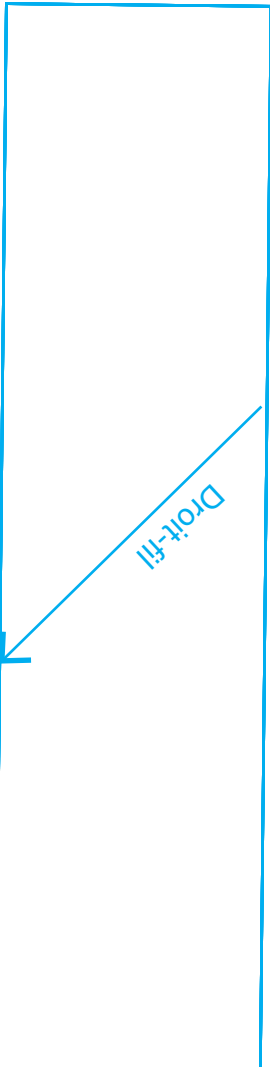
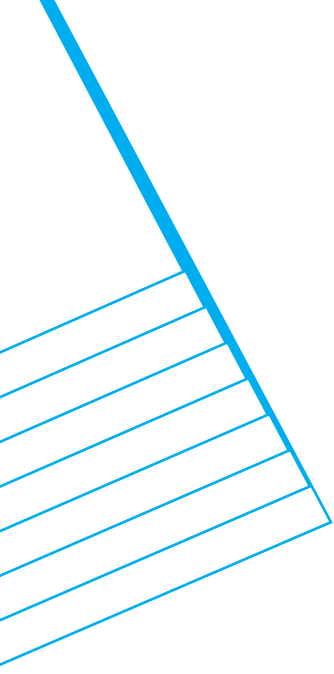

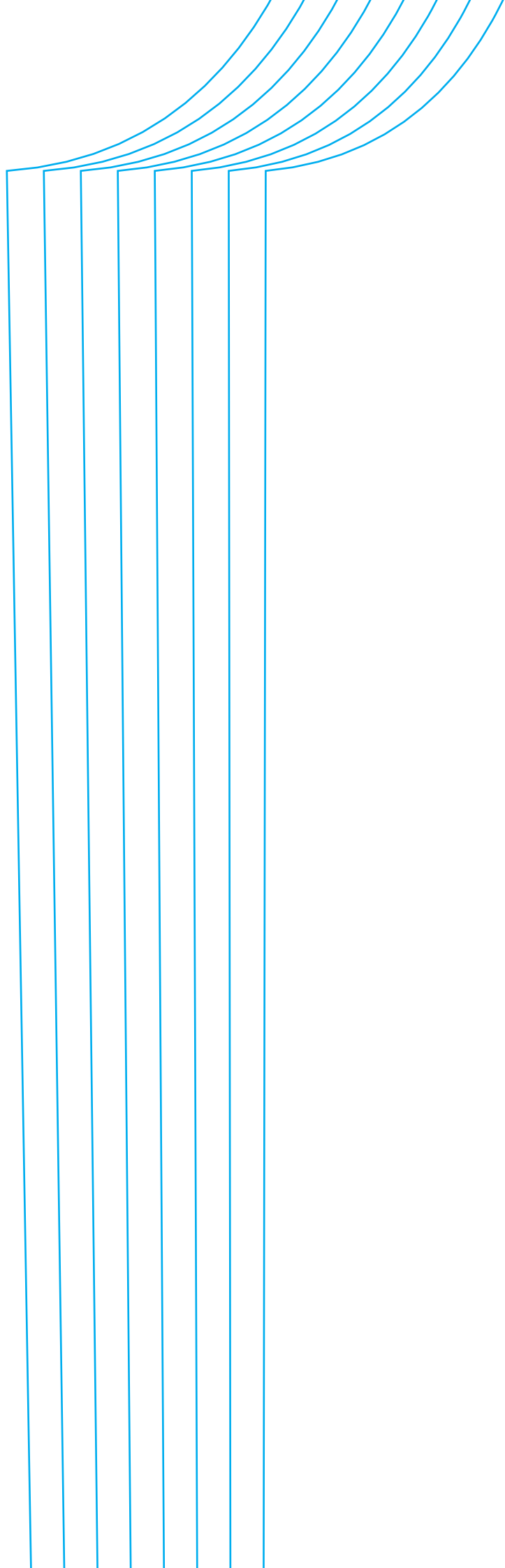



**BLONDIE
JAMBE DOS**

À couper 2 X tissu

Pièce coupée en 2 (partie 2/2)

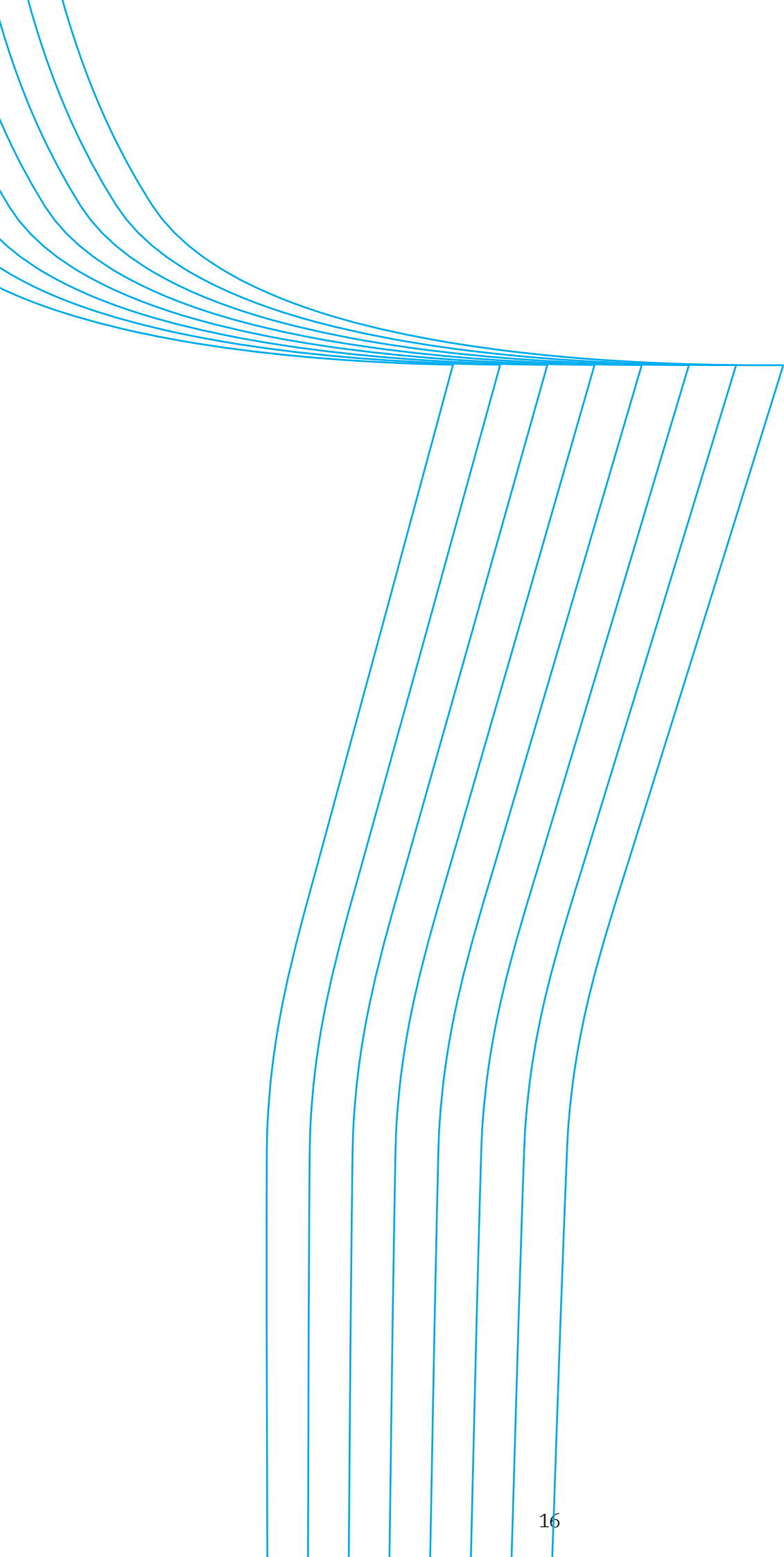

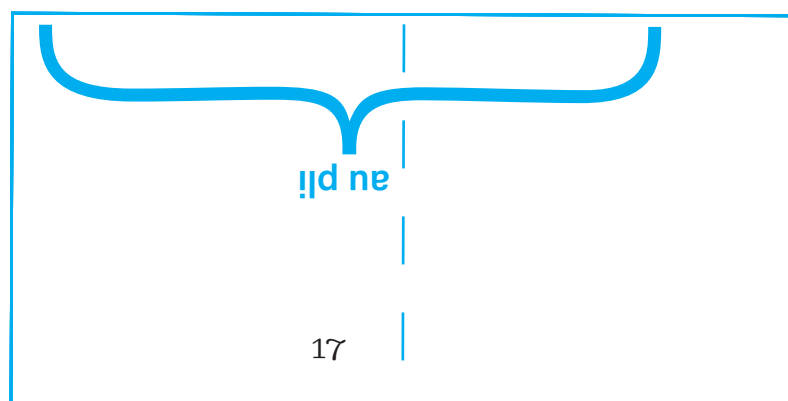
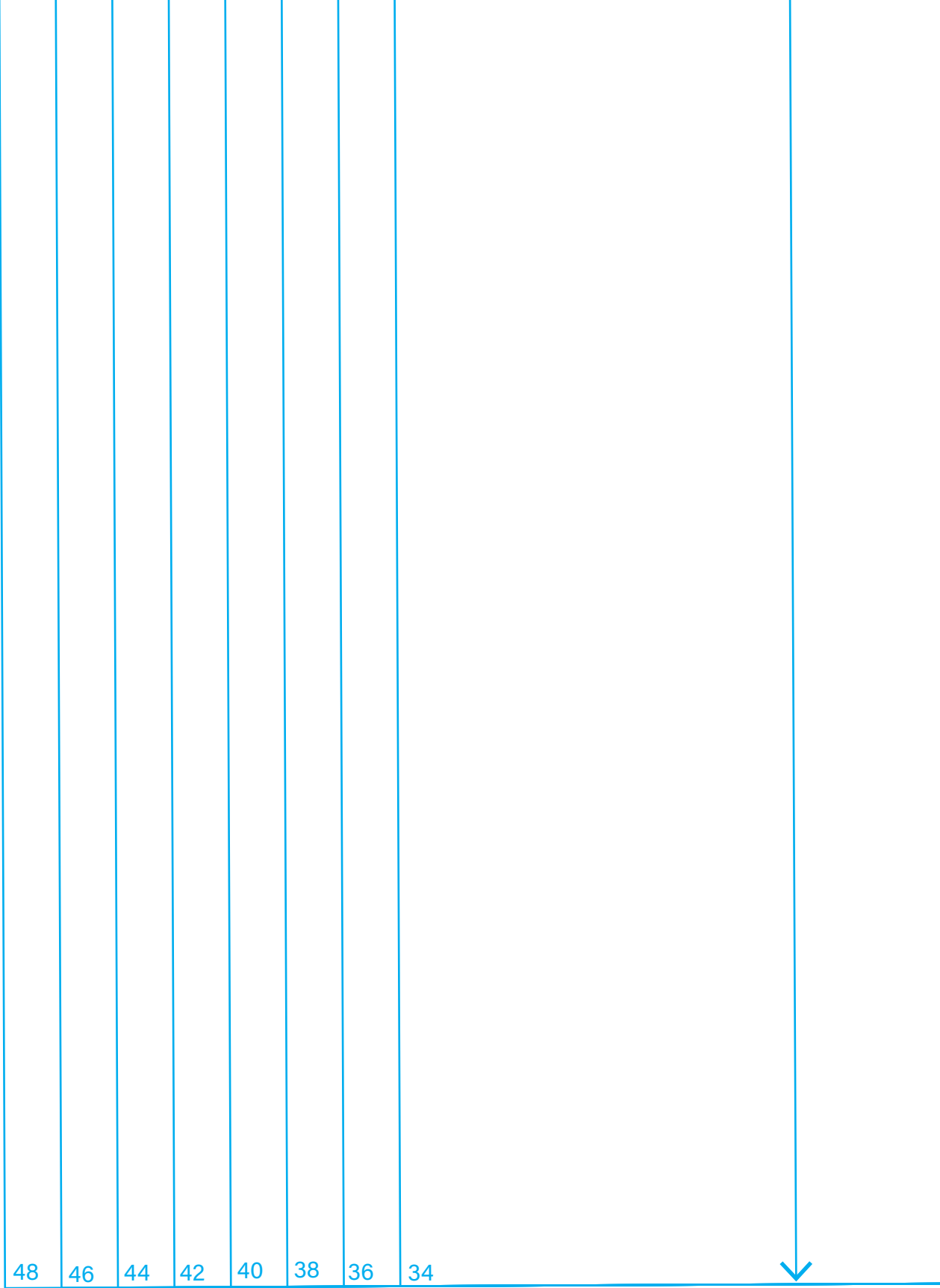

**BLONDIE
HAUT DEVANT**

À couper 2 X tissu

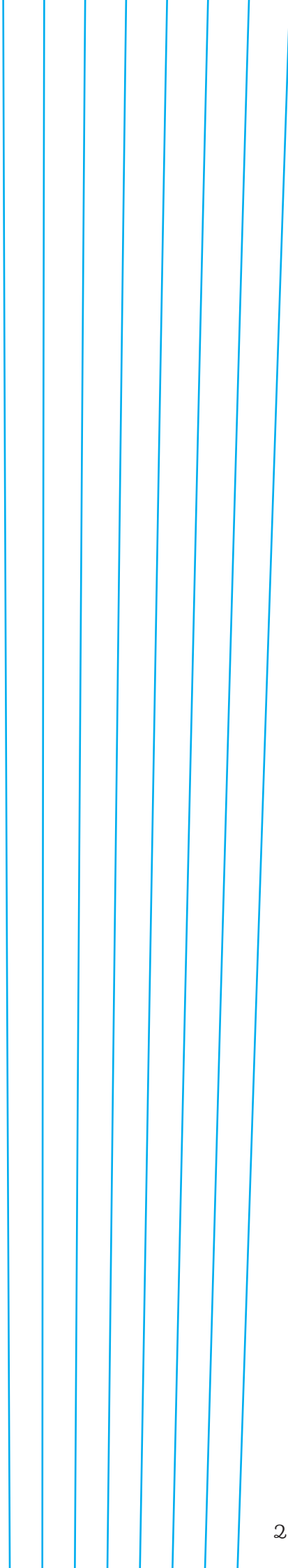

**BLONDIE
CEINTURE**

À couper 1 X tissu au pli

repère
ouverture

ONDIE - POCHÉ
couper 4 X tissu

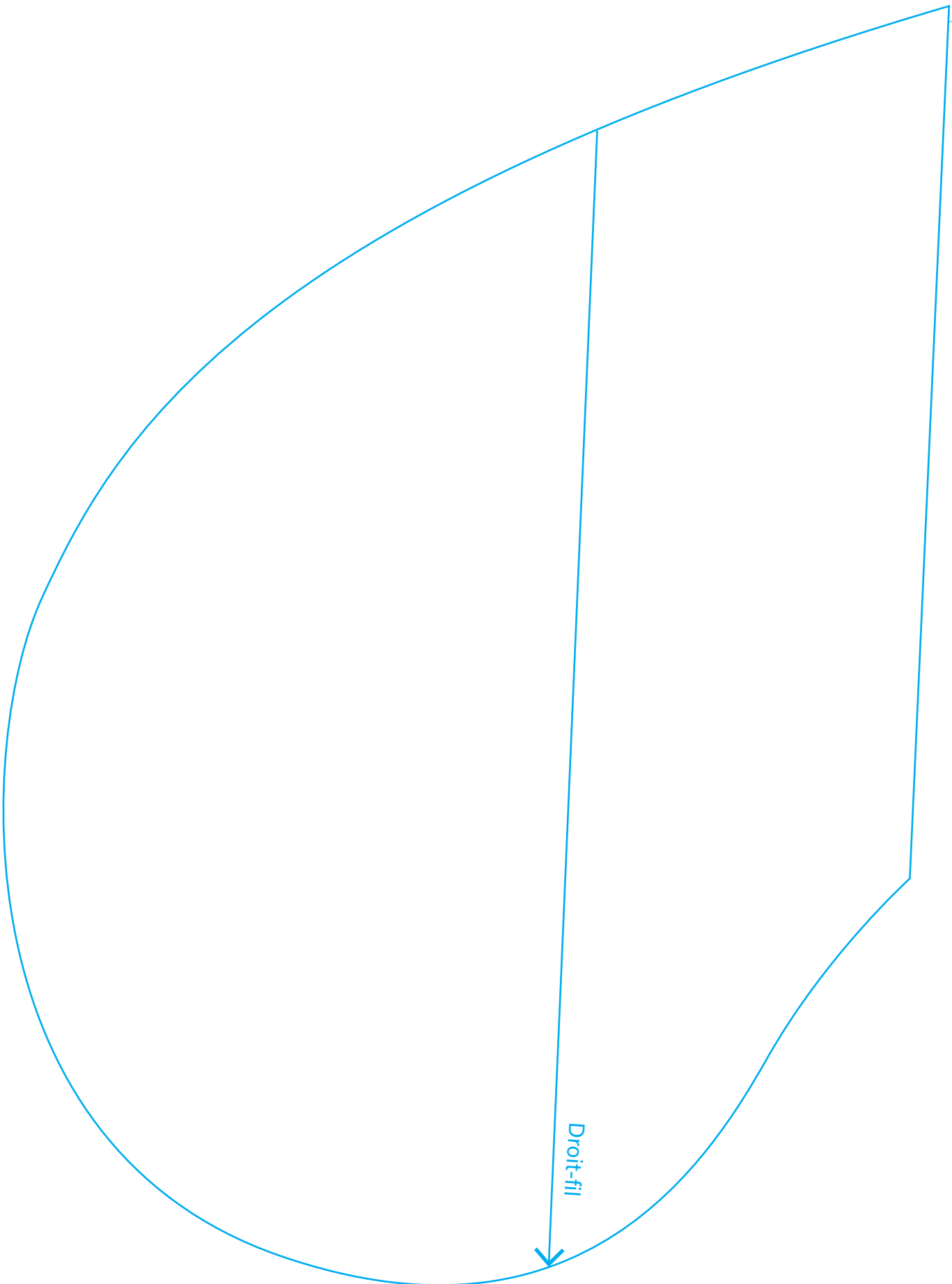

Droit-fil

PATTE DE BOUTONNAGE

À couper 2 X tissu
et 2 X thermocollant

ligne de pliure



34	36	38	40	42	44	46	48
----	----	----	----	----	----	----	----

BLONDIE - BIAIS D'ENCOLURE
À couper 1 X tissu

BLONDIE JAMBE DEVANT

À couper 2 X tissu Pièce coupée en 2 (partie 2/2)

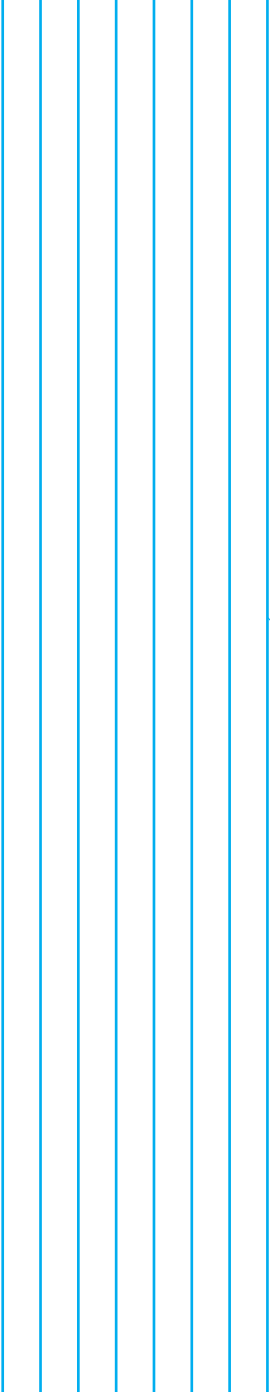

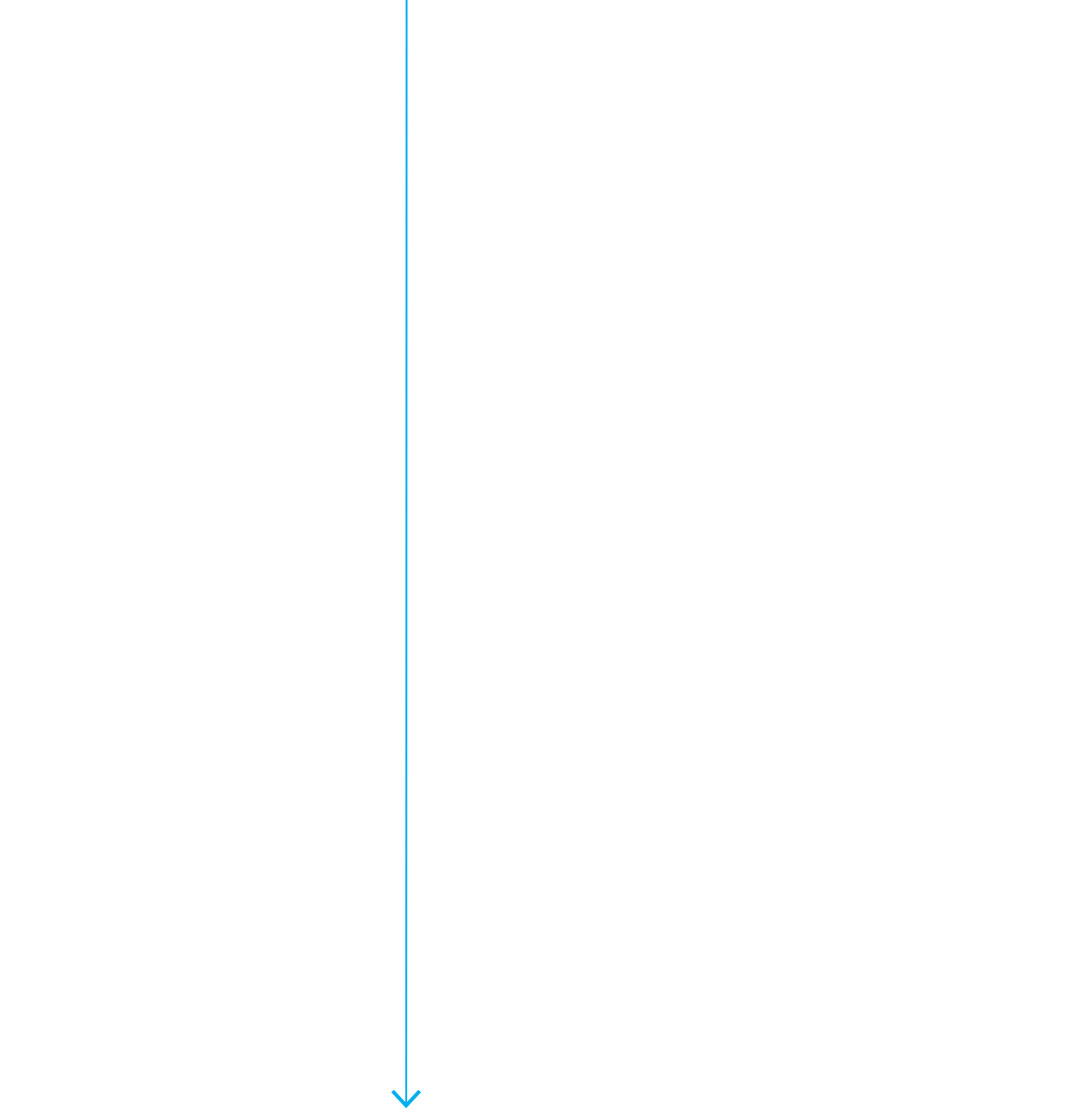

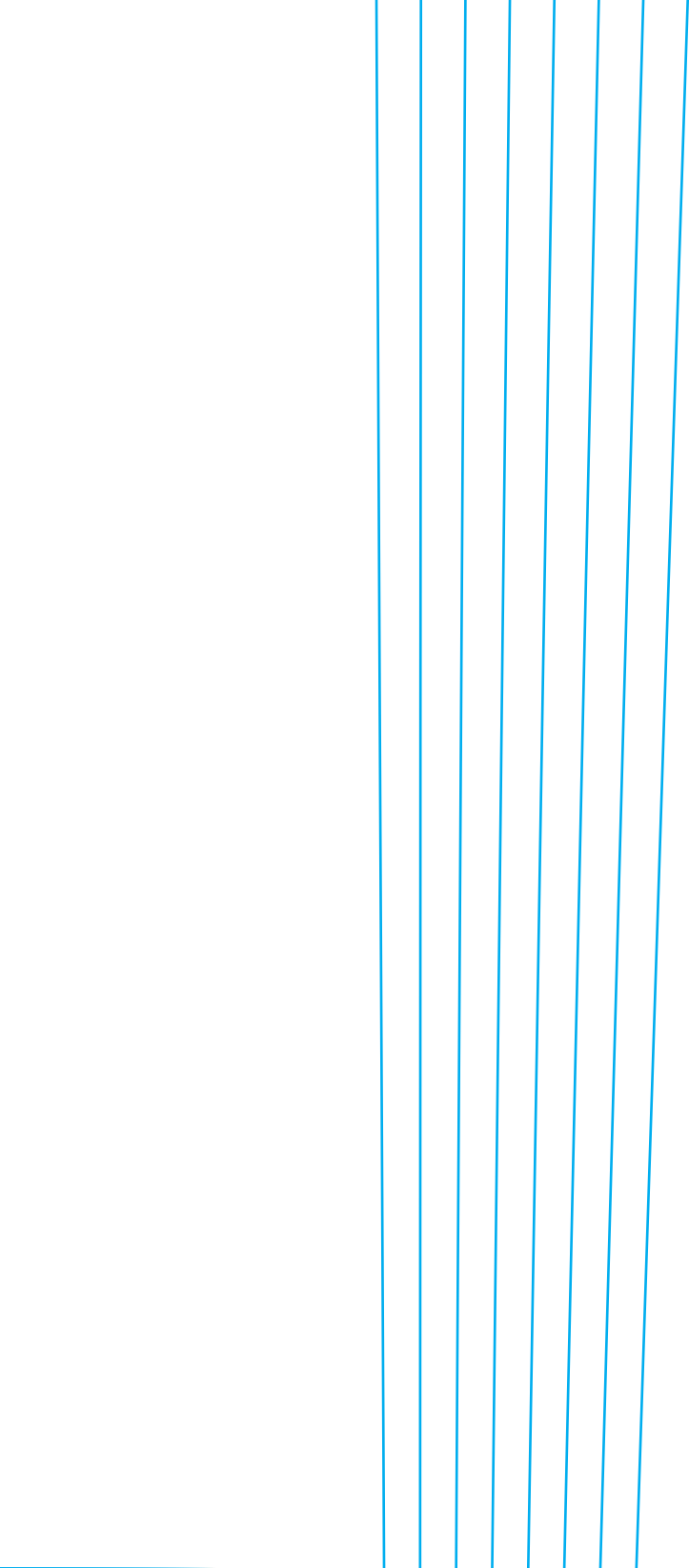

Droit-fil



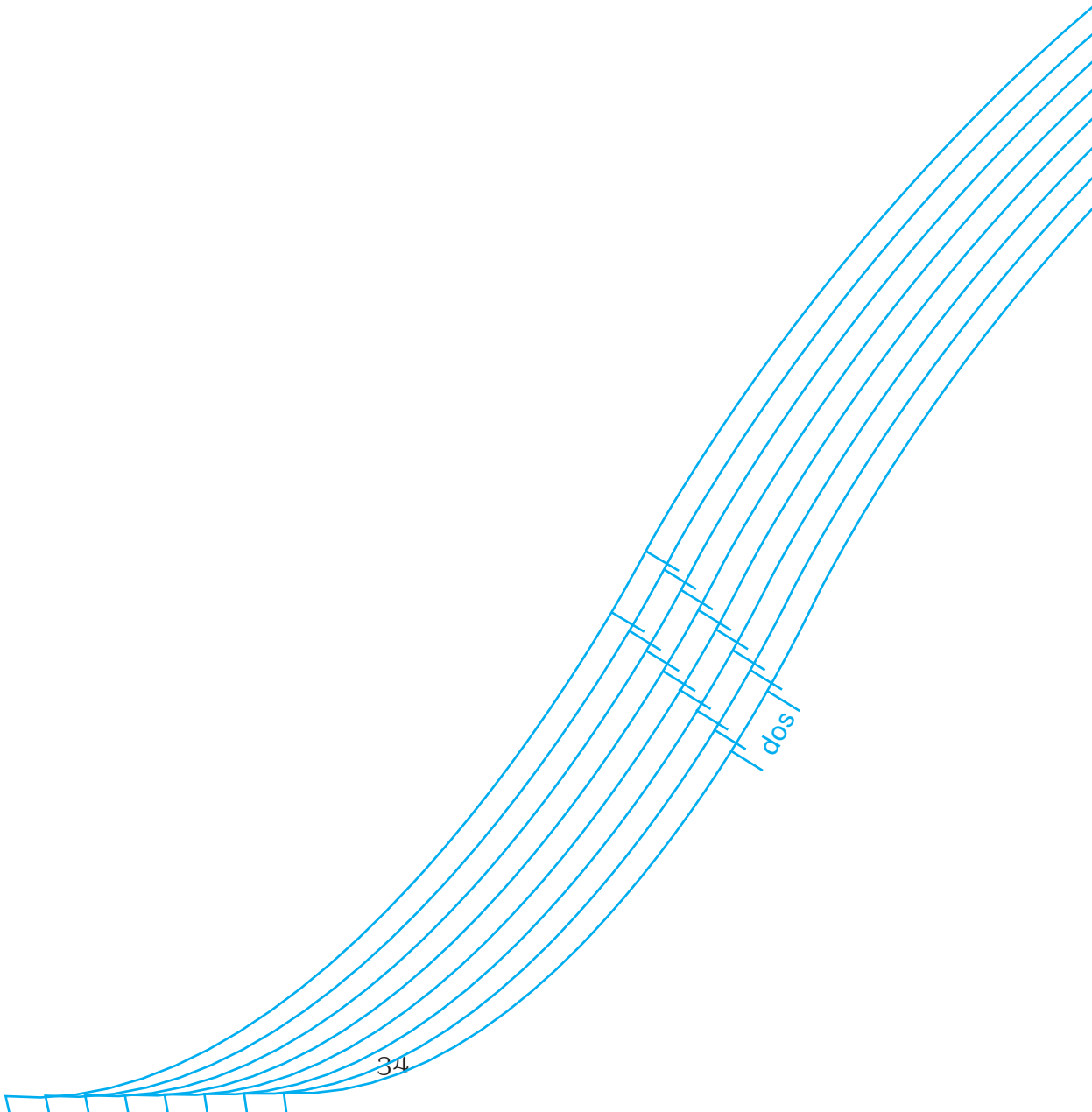

dos

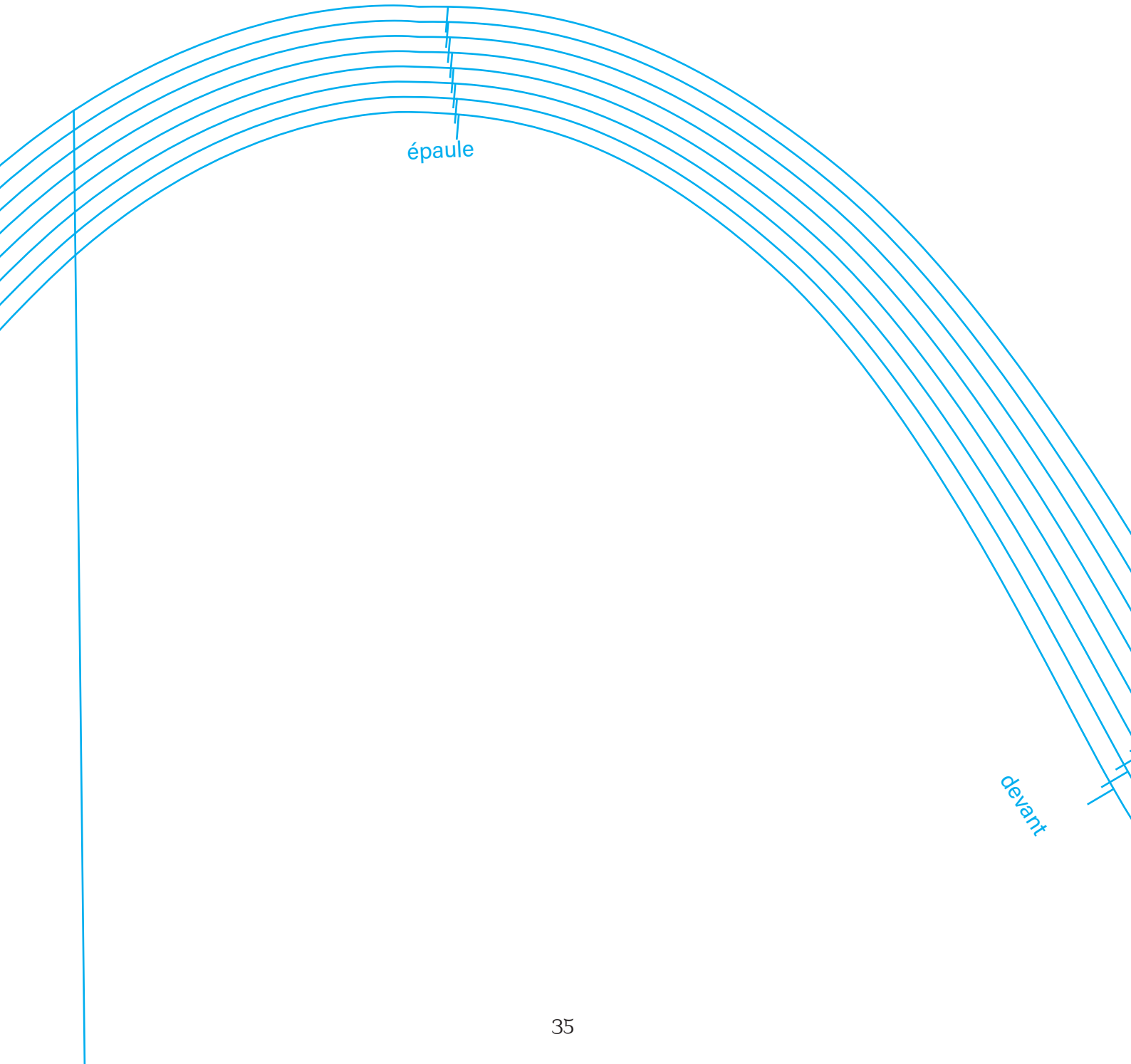
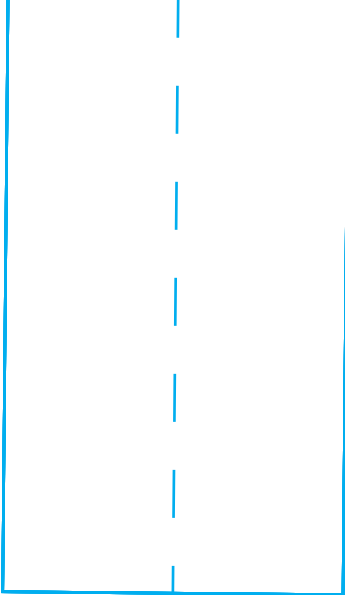

BLONDIE
MANCHE
A couper 2 X tissu

34 36 38 40 42 44 46 48 36

BLONDIE
HAUT DOS
À couper 1 X tissu au pli!

Droit-fil

milieu dos

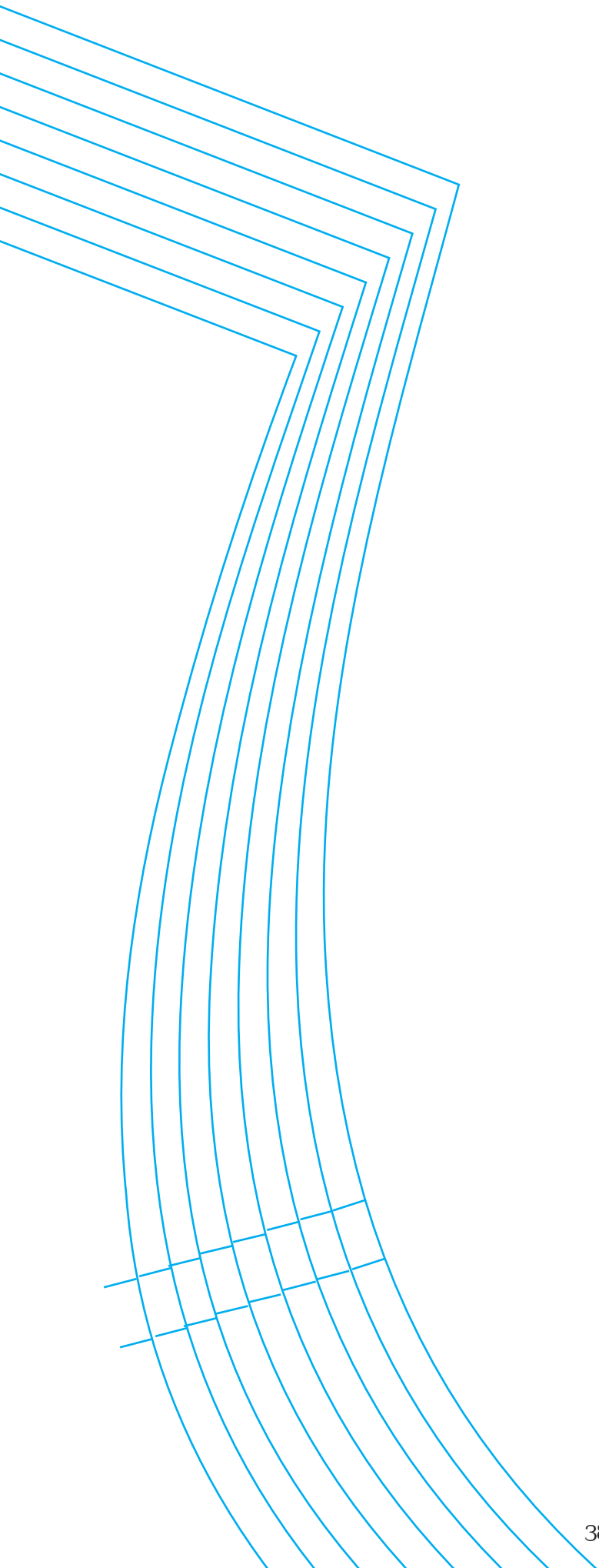

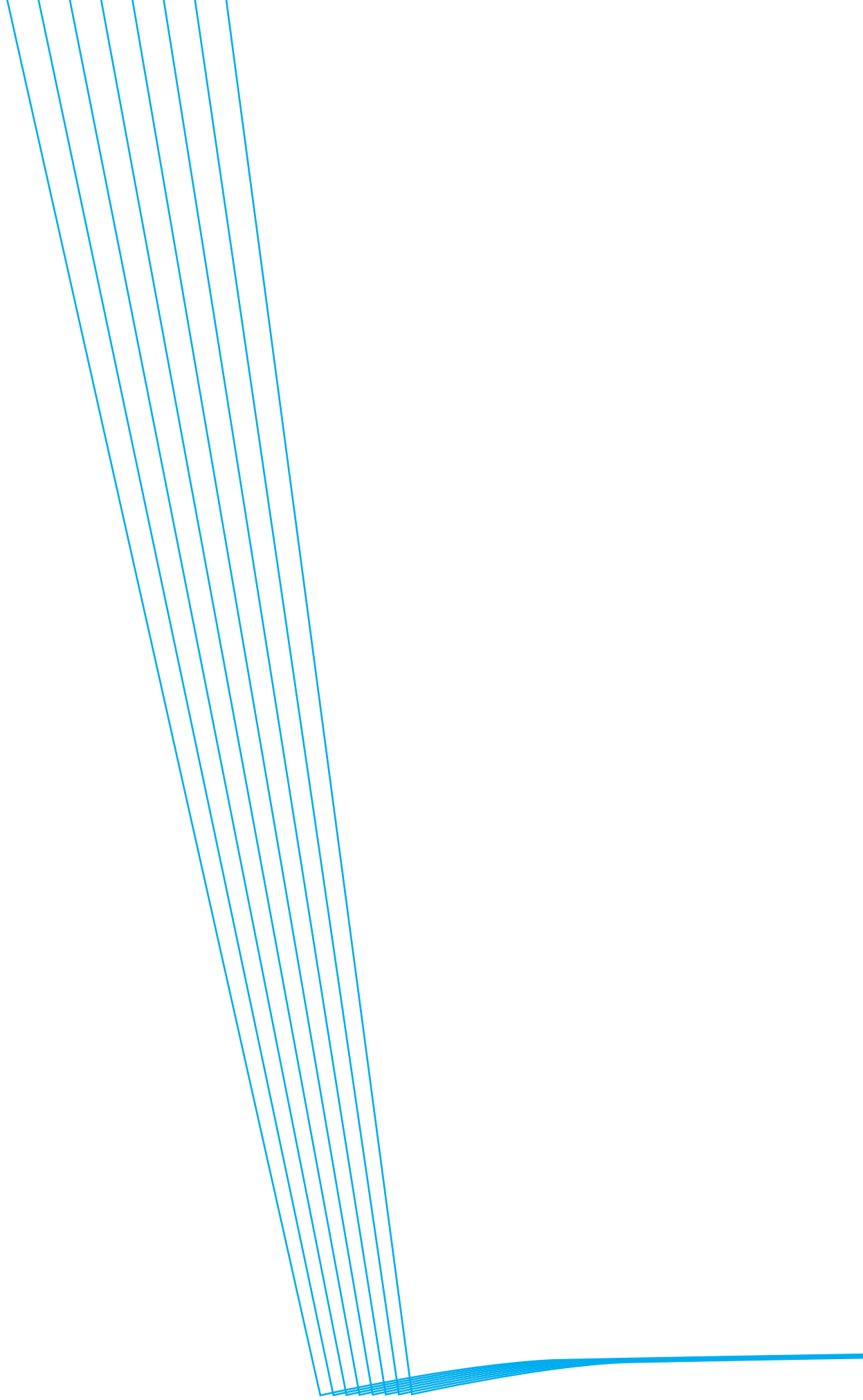

Droit-fil



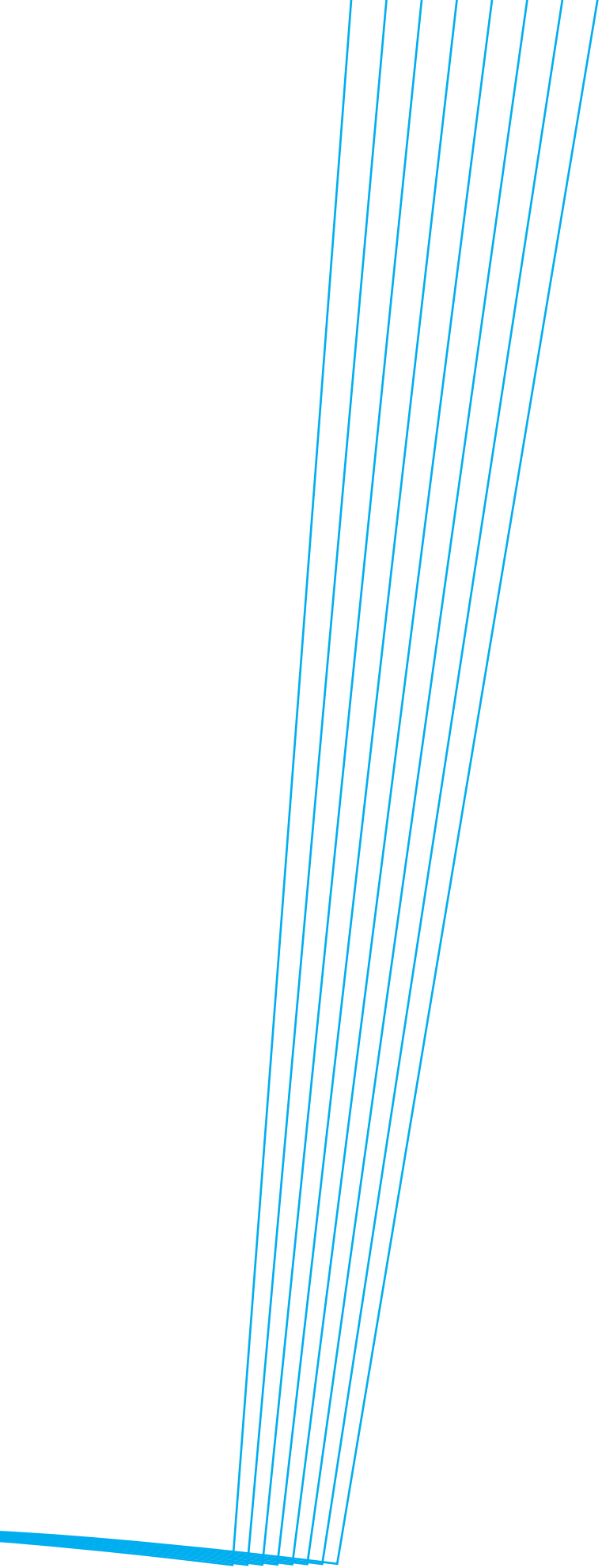

au pli

34 36 38 40 42 44 46 48